

# Operating Instructions

## Melitta® Cafina® XT5

Melitta Professional  
Coffee Solutions





<b>1</b>	<b>General</b>	<b>4</b>	6.8	Multiple dispensing of a single product	18
1.1	Manufacturer information	4	6.9	Batch mode	18
1.2	About these instructions	4	6.10	Product dispensing via product filter	19
1.3	Explanation of symbols	4	6.11	Preparing coffee from coffee powder	20
1.4	Description	4	<b>7</b>	<b>Settings</b>	<b>20</b>
1.5	Accessories	5	7.1	Opening the manager menu	20
1.6	Conformity	5	7.2	Carrying out inputs	21
<b>2</b>	<b>Safety</b>	<b>5</b>	7.3	Exiting the manager menu	21
2.1	Intended use	5	7.4	Menu option "Selection"	21
2.2	Safety information	5	7.4.1	Product groups	21
2.2.1	General	5	7.4.2	Creating product groups	21
2.2.2	Personnel	6	7.4.3	Deleting product groups	22
2.2.3	Correct use	6	7.4.4	Editing product groups	22
<b>3</b>	<b>Technical data</b>	<b>7</b>	7.4.5	Adding dispensing products	22
<b>4</b>	<b>Installation</b>	<b>7</b>	7.4.6	Deleting dispensing products	22
4.1	Prerequisites	7	7.4.7	Sorting dispensing products	22
4.1.1	Water connection	7	7.5	Menu option "Product filter"	23
4.1.2	Electrical connection	7	7.5.1	Adding main criterion	23
4.1.3	Installation location	8	7.5.2	Deleting main criterion	23
4.1.4	Product material	8	7.5.3	Editing main criteria	23
4.2	Canister operation (option)	8	7.6	Menu option "Product"	23
4.2.1	Filling the fresh water canister	9	7.6.1	Changing products	23
4.2.2	Emptying the waste water canister	9	7.6.2	Duplicating a product	24
<b>5</b>	<b>Operation</b>	<b>9</b>	7.7	Menu option "Unit"	24
5.1	Chip keys	9	7.7.1	Menu option "Filling levels"	24
5.1.1	Green user chip keys	9	7.7.2	Menu option "Maintenance"	25
5.1.2	Yellow manager chip key	9	7.8	Menu option "Operation"	25
5.1.3	Without chip keys	9	7.8.1	Opening usage statistics	25
5.1.4	Logging in with a chip key	10	7.8.2	Opening product statistics	26
5.2	Switching the machine on and off	10	7.8.3	Machine settings	26
5.2.1	Switching on	10	7.8.4	Logging	27
5.2.2	Stand-by operation	10	<b>8</b>	<b>Cleaning</b>	<b>28</b>
5.2.3	Switching off	11	8.1	Safety measures	28
5.3	Filling	11	8.2	Cleaning intervals	28
5.3.1	Filling the coffee supply	11	8.3	Cleaning prompt and dispensing lock	28
5.3.2	Filling the instant powder (option)	12	8.4	Cleaning agent	29
5.3.3	Filling the milk (option)	13	8.5	When using canisters	29
5.4	Confirming filling levels	13	8.6	Daily cleaning	29
5.5	Emptying the coffee grounds drawer	14	8.6.1	Cleaning the coffee grounds drawer	29
5.6	Locking the product choice	14	8.6.2	Running the cleaning program	29
5.7	System messages	15	8.6.3	Cleaning the instant system	31
5.7.1	Messages in self-service operation	15	8.7	Cleaning the bean container	33
5.7.2	Messages in waiter operation	15	8.8	Cleaning the instant container	33
<b>6</b>	<b>Dispensing products</b>	<b>15</b>	8.9	Cleaning the touch screen	34
6.1	Product dispensing	15	8.10	External cleaning	34
6.2	Canceling the product dispensing	16	<b>9</b>	<b>Maintenance</b>	<b>35</b>
6.3	Dispensing coffee, coffee and milk, and milk products	16	9.1	Intervals	35
6.4	Dispensing hot water (option)	16	9.2	Faults	35
6.5	Dispensing steam (option)	17	<b>10</b>	<b>Recycling and disposal</b>	<b>35</b>
6.6	Dispensing a double product	17	10.1	Waste disposal	35
6.7	Dispensing multiplier products	18	10.2	Waste water disposal	35
			10.3	Disposal of cleaning agents	35
			10.4	Disposal of the machine	35



General	1
Safety	2
Technical data	3
Installation	4
Operation	5
Dispensing products	6
Settings	7
Cleaning	8
Maintenance	9
Recycling and disposal	10

**Translation of the original operating instructions**



## 1 General

### 1.1 Manufacturer information

Melitta Professional Coffee Solutions GmbH & Co. KG  
 Zechenstr. 60  
 32429 Minden  
 Germany  
 Internet: www.melitta-professional.de

### 1.2 About these instructions

These instructions form part of the equipment. They contain important information on safety, installation, usage, and cleaning. Observing these instructions helps preserve your safety and helps avoid damage to the product.

We reserve the right to make changes to these instructions due to technical modifications. Reprints, translations and reproductions in any form, including excerpts, require written agreement from the publisher.

The copyright is held by the manufacturer.

### 1.3 Explanation of symbols

#### ⚠ DANGER

##### Danger of death!

Identifies hazards that could result in serious harm or even death if the corresponding hazard notice is not observed.

#### ⚠ WARNING

##### Personal injury!

Identifies hazards that could result in harm if the corresponding warning notice is not observed.

#### ⚠ CAUTION

##### Minor injuries!

Identifies hazards that could result in minor injuries.

#### ATTENTION

##### Property damage!

Identifies the risk of possible property damage.

#### ► Note

Identifies usage tips and useful information.

### 1.4 Description

This machine is an automated coffee machine. Depending on the machine equipment level, the following products can be dispensed:

- Coffee, coffee and milk, and milk products
- Instant products
- Hot water and steam

The housing is made from aluminum and high-quality plastic. The design of this machine permits the following operator requirements to be observed:

- HACCP hygiene guidelines
- Accident prevention regulations for electrical safety in the commercial sector



Fig. 1: Overview

- 1 Bean container 1 (front)
- 2 Bean container 2 (rear)
- 3 Chute (rear bean container 1)
- 4 Instant container cover (including instant container)
- 5 Mixer unit (behind the unit door)
- 6 Machine door with display (touchscreen)
- 7 Chip key contact surface
- 8 Hot water lance (option)
- 9 Product outlet (height-adjustable)
- 10 Coffee grounds drawer (behind the grounds drawer door)
- 11 Drip grid
- 12 Steam lance (option)
- 13 Main switch (behind the machine door)

The nameplate is located on the inside of the grounds drawer door.



## 1.5 Accessories

### Accessories supplied

- 2 green user chip keys
- 1 yellow manager chip key
- 1 cleaning container
- 1 drain clip
- 1 extraction tool
- 1 tin of coffee cleaning tabs (art. no. 24718)
- 1 container milk cleaner liquid concentrate (RFM) (art. no. 24720)
- 1 coffee measure 6 g
- 1 set of operating instructions

### Accessories available

Cup warmer	XT CW30
Milk coolers	XT MC18, XT MC30, XT MCU30
Combined milk cooler/ cup warmer unit	XT MC-CW30
Accounting systems	Coin checker, coin changer, card reader
Grounds disposal	Container drop
Supply containers	Lockable bean containers

## 1.6 Conformity

The manufacturer hereby declares that the product described in these operating instructions complies with the EU Directive on "electromagnetic compatibility", the Directive on the "restriction of the use of certain hazardous substances in electrical and electronic equipment", and, where applicable, the "Machinery Directive" and "Low Voltage Directive". Further relevant details can be found in the EU declaration of conformity provided separately.

## 2 Safety

### 2.1 Intended use

This machine is an automated coffee machine for dispensing coffee, coffee and milk, and milk products as well as hot water with increased daily requirements for beverages in the gastronomic sector.

The following operating modes are available:

- Operation by trained personnel
- Supervised self-service operation (SS mode)
- Operation with fixed water connection
- Non-pressurized operation via fresh water and waste water canisters
- Stationary installation within dry, enclosed rooms

This machine is **not** intended for the following uses:

- Areas with high air humidity (e.g., areas with considerable amounts of steam) or outdoors
- On board vehicles or mobile facilities (please contact the manufacturer)

### 2.2 Safety information

#### 2.2.1 General

The following safety instructions relate to the machine only. There may also be legal requirements placed on the owner/operator, such as appropriate food hygiene and work safety.

- Only use the machine when you have read and understood the instructions in full.
- When operating the machine, always observe all information and guidelines in these instructions.
- Keep these instructions at the place of use of the machine.

### 2.2.2 Personnel

- This machine is only permitted to be used by children of 8 years and over as well as persons with reduced physical, sensory or mental capabilities if supervised or trained in the safe use of the equipment.
- Children under 8 years of age must be kept away from the machine.
- Children must not be permitted to play with the equipment.
- Cleaning and user maintenance may only be carried out by children if they are properly supervised.
- Persons with limited experience and knowledge must be able to recognize hazards arising from incorrect operation.
- A user is only permitted to operate the machine without supervision if the machine has been explained to that user to facilitate safe operation.
- In self-service operation, the machine must be supervised by trained personnel.
- Repairs and maintenance work may only be carried out by Melitta customer service or by specialist personnel authorized by the manufacturer. Incorrectly performed repair work can result in considerable risk to the user.
- The area reserved specifically for customer service is only to be accessed by persons who have sufficient knowledge and practical experience of the equipment, particularly with regard to safety and hygiene.
- Settings, cleaning and preparations on the machine are only permitted to be carried out by persons trained by the installation engineer or by the manufacturer.
- Faulty components must always be replaced by original spare parts. Otherwise the warranty conditions will be void.

### 2.2.3 Correct use

- The machine can be damaged due to water penetration. The machine is not protected against jets of water. Protect the machine against water and spray water.
  - Never hose down the machine with water.
  - Do not use any water jets, high-pressure or steam cleaners to clean the machine.
  - The machine is not suitable for installation on a surface where a water jet might be used.
- When the machine is unattended for extended periods, switch it off at the main switch and close the water tap.
- Never open the covers unless explicitly instructed to do so. Similarly, never remove bolts and the housing parts that they hold in place. Contact with live parts poses a danger of death due to electrical voltage.
- Never reach into a machine opening when the machine is running.
- Do not hold any body parts under the outlets when hot liquids or steam are being dispensed. This occurs in the following situations:
  - After switching on
  - When beverages are being dispensed
  - During automatic cleaning
  - During the rinsing process (e.g., when switching off)
- Do not touch any hot parts.
- When products are being dispensed, there is a risk of scalding from the actual products. Always take care when handling hot beverages.
- Take note of any visible damage or malfunctions. Obvious malfunctions include water leaks, odors and heat formation, unusual noises, as well as error messages on the display. In the event of any unusual situations:
  - Remove the mains plug
  - Switch off the water supply
  - Contact customer service
  - Have the machine checked and serviced by customer service
- Clean the machine at least once per day, especially the parts transporting milk. Impurities could cause health problems.
- Comply with all intervals for cleaning, inspection, and maintenance, as specified in the instructions. Otherwise, the safety, functional reliability, and durability may be impaired.





### 3 Technical data

#### Machine specifications

Dimensions (W x D x H)	300 x 580 x 715 mm
Weight	approx. 60 kg
Coffee supply	2 x 3 l / 2 x approx. 1000 g
Instant supply	1 x 1.7 l / 1 x approx. 1300 g or 2 x 1 l / 2 x 450-800 g
Coffee grounds drawer capacity	For approx. 30 portions

#### Operating data

Hourly output	approx. 20 l hot water or approx. 100 cups of café crème
Permitted ambient temperature	+ 5-30 °C
Permitted air humidity	< 80 % non-condensing

#### Connections

Power supply	200-240 V, 50-60 Hz
Power consumption	2175-3040 W
Fuse protection provided by customer	16 A (required)
Connection	1.8 m mains cable with shock-proof mains plug
Fresh water connection	G ¾" outer thread
Fresh water pressure	At least 0.25 MPa (2.5 bar) at approx. 2 l/min., a pressure reducer is required for static pressures of 0.6 MPa (6 bar) and above
Fresh water carbonate hardness	1-3 °dKH no action required; 4 °dKH and above: decarbonization system required (e.g., BRITA-Purity); less than 1 °dKH: consult manufacturer
Waste water connection	At least DN 25 - NW 1"
Noise level	< 70 dB(A)

### 4 Installation

The machine is set up, installed, and handed over ready for use by customer services. Have all modifications to the installation or setup carried out by customer services due to the associated hazards.

#### 4.1 Prerequisites

Make sure that the following prerequisites are met before you use the machine.

##### 4.1.1 Water connection

The water connection must be easy to turn off at any time during operation (stop valve). Any relevant national regulations must be observed when connecting this machine to the water supply, e.g., EN 61770.

The limit values for water pressure and carbonate hardness as given in the technical data must be observed.

Only use a new tube set. Old or used tube sets are not permitted to be re-connected.

The water drain is only permitted to be installed via a permanent connection with an odor trap protected against blockages and backflow.

This prevents contamination in the machine due to backflow waste water.

##### 4.1.2 Electrical connection

The supply voltage must match the specifications on the nameplate.

The supply line must be protected at the site using a residual current circuit breaker (RCCB) (max. 30 mA).

For connection via a mains plug, the socket must be easily accessible during operation so that the plug can be disconnected in the event of a fault.

Due to the high load, a single fused circuit is required for the machine.

**4.1.3 Installation location**

The machine is only to be installed and used in enclosed, dry areas; it must not be operated outdoors.

The effects of humidity and temperature may adversely affect the function and safety of the equipment.

The machine must always be installed and stored in frost-free locations.

The installation area must provide sufficient distance from walls and objects due to the heat generated and for operation of the machine.

**Distances**

To the back	At least 5 cm
To the top	At least 20 cm

For self-service operation, the machine and all accessory units must be installed in such a way that it can be permanently monitored by instructed personnel.

The machine must be positioned level and free of vibrations. The adjustable equipment feet can be used for alignment on slightly uneven surfaces.

**4.1.4 Product material**

Coffee beans must be suitable for use in commercial coffee machines.

Extraneous matter such as pieces of wood, stones, or metal, etc., must be removed to prevent damage to the grinder.

Ground coffee or instant powder must be suitable for use in commercial coffee machines. Only use dry and loose material without clumps.

To ensure milk foam of the best possible quality, use ultra-heat treated (UHT) milk cooled to a temperature of 3 °C (±2 °C).

Do not use milk that has not been treated in a dairy. Lactose-free milk, milk from animals other than cows, soy milk, alternative sources of protein, or additives can be used; however, the cleaning of the milk system cannot be ensured. The machine's operator is responsible for any breakdowns and work by the customer service team.

**4.2 Canister operation (option)**

If your machine cannot be permanently connected to the fresh water and waste water system, you can also operate it with two canisters.

Also observe the limit values for the water carbonate hardness in this process. Where necessary, the fresh water supply must be topped up via a water filter (e.g., BRITA-Purity).

The canisters must always be installed by customer service.

**Note**  
Particular care with hygiene is required for canister operation. Observe the relevant notes in chapter 8.5 on page 29.

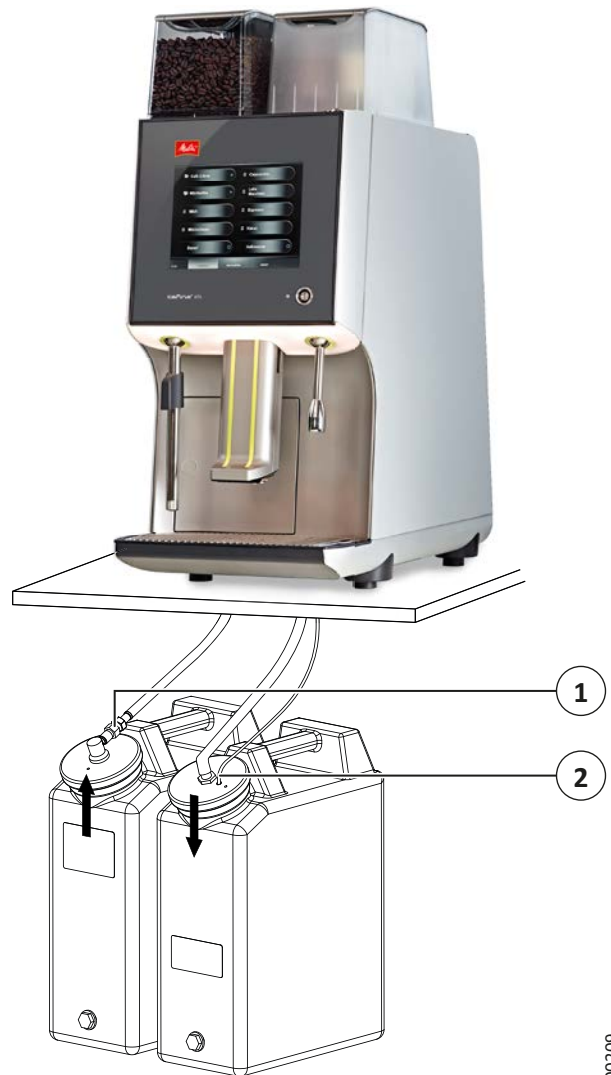

Fig. 2: Canister operation

000209





In daily operation, the fresh water canister must be filled with sufficient water and the waste water canister drained as necessary.

#### 4.2.1 Filling the fresh water canister

1. Unfasten the quick-connect coupling of the infeed tube (1).
    - Move the ring backwards on the coupling piece.
    - Remove the plug connector from the coupling piece.
  2. Unscrew the cover from the canister.
  3. Before filling, clean the fresh water canister and its cover area with standard dishwashing agent and rinse the cleaner residues thoroughly.
  4. Fill the canister with fresh water.
    - Observe the limit values for the water carbonate hardness. Where necessary, the fresh water supply must be topped up via a water filter (e.g., BRTA-Purity).
  5. Screw the cover back onto the canister.
  6. Connect the supply tube (1) to the canister.
    - Fit the plug connector onto the coupling piece.
    - Check that the plug connection is secure.
- ✓ The fresh water canister is ready for operation.

#### 4.2.2 Emptying the waste water canister

1. Remove the discharge tube (2) from the canister cover.
  2. Unscrew the cover from the canister.
  3. Empty the canister.
  4. Screw the cover back onto the canister.
  5. Insert the discharge tube (2) through the hole in the canister cover.
- ✓ The waste water canister is ready for operation.

## 5 Operation

Initial commissioning is carried out by customer service. If you want to put the machine back into operation following a standstill, clean the machine as described (see chapter 8 on page 28).

### 5.1 Chip keys

Included with the machine are two green user chip keys and one yellow manager chip key.

#### 5.1.1 Green user chip keys

The green user chip keys can be used to carry out the following actions:

- Switching the machine on/off
- Changing the filling levels
- Carrying out a full clean of the machine
- Cleaning the touch screen

#### 5.1.2 Yellow manager chip key

The yellow manager chip key provides the same options as the user chip key. The following additional actions can be carried out:

- Making settings on the machine
- Editing the dispensed products
- Creating/editing product groups
- Displaying consumption and product statistics

#### 5.1.3 Without chip keys

##### Waiter operation

Without a chip key, the following options are available in waiter operation:

- Dispensing preset products
- Emitting steam
- Switching off the machine
- Changing the filling levels
- Carrying out a full clean of the machine
- Cleaning the touch screen

##### Self-service operation

Without a chip key, you can only dispense preset products in self-service operation.

### 5.1.4 Logging in with a chip key



000210

Fig. 3: Logging in with a chip key

1. Hold one of the chip keys on the contact surface (1) on the front of the machine so that the inner and outer contact surfaces are fully connected to one another by the chip key.

✓ You are logged in and can use the corresponding functions.

5

## 5.2 Switching the machine on and off

### 5.2.1 Switching on



000107

Fig. 4: Switching on the machine

1. Check that the water supply is on.
2. Open the machine door (3) using the key (1).
3. Switch the machine on using the main switch (2).
4. Close the machine door.
5. Continue as described in chapter 5.2.2 on page 10.

► **Note**  
The main switch can be used to switch the machine off entirely, e.g., during extended standstills.

### 5.2.2 Stand-by operation

In daily operation, it is sufficient to switch the machine on and off via the display only (stand-by operation):

1. Depending on the operating mode, proceed as follows:
  - **Self-service operation:** Hold one of the chip keys on the contact area on the front of the device.
  - **Waiter operation:** Touch the display.

The question "Switch on unit?" is shown on the display.



000151

Fig. 5: Turn on the machine

2. Confirm this using "Yes".

The switch-on process is started and takes a few minutes.

**▲ CAUTION**

**Danger of burns on the beverage outlet!**

Hot water runs out of the beverage outlet when the lines are rinsed.

- Do not reach underneath the outlets.
- 
- The lines are rinsed.
  - The machine is heated to the required temperature.
  - The required temperature is built up in the steam boiler.

The switch-on process is displayed by a flashing LED next to the chip key contact surface. The LED lights up permanently when the machine is ready for dispensing.

✓ The machine is ready for operation.

► **Note**  
After switching on the machine, the filling levels of the supply containers must be checked. If necessary, the supply containers must be filled and the filling levels confirmed.

### 5.2.3 Switching off

- **Note**  
For hygiene reasons, the machine must always be cleaned before switching off.

Always use the "Clean and switch off full system" function. The "Switch off" function (in the manager menu) is only permitted to be used if a cleaning process has been carried out and no further products have been dispensed.

When switching off, the machine goes to standby mode.

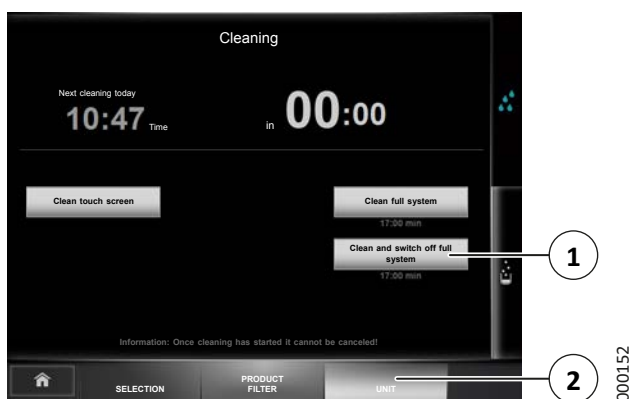

Fig. 6: Switching off the machine

1. On the display, press the "Unit" button (2).
    - To use self-service operation, you must first log in with a chip key (see chapter 5.1.4 on page 10).
  2. Press the "Clean and switch off full system" button (1).
    - The next steps are described in chapter 8.6 on page 29.
- ✓ The cleaning program is carried out. The machine is then switched off.

### For an extended standstill

If the machine will not be used for an extended period, turn off the water supply and switch off the main switch.

- **Note**  
For hygiene reasons, the machine must always be cleaned before switching off.

If you want to take the machine out of operation, contact customer service.

### 5.3 Filling

- **Note**  
The filling level in the machine must be confirmed each time a supply container is filled (see chapter 5.4 on page 13).

#### 5.3.1 Filling the coffee supply

There will be one or two bean containers depending on the equipment.



Fig. 7: Filling the bean container

1. Remove the cover on the bean container.
  2. Fill the correct beans into the corresponding bean container, e.g., espresso beans in container 1 (1) and coffee beans in container 2 (2).
  3. Re-fit the cover.
- ✓ The bean container has been filled.

To simplify filling, the relevant container can be removed.

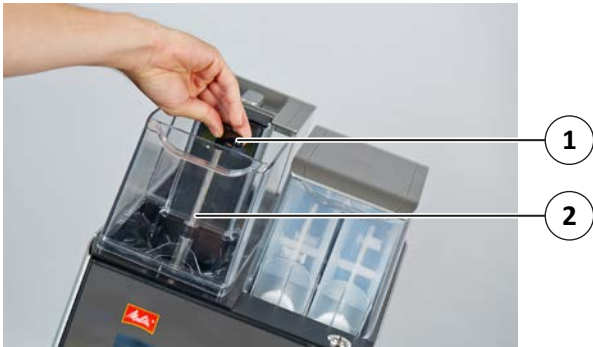

Fig. 8: Removing the bean container

000212

1. Remove the cover on the bean container.
2. Turn the lever (1) a  $\frac{3}{4}$  turn counterclockwise.
3. Remove the bean container (2).
4. Fill the coffee beans into the bean container.
5. Re-fit the bean container back into the machine.
6. Turn the lever a  $\frac{3}{4}$  turn clockwise back to the original position.
7. Re-fit the cover.

✓ The bean container has been filled.

► **Note**  
The coffee grounds drawer should also be emptied every time the coffee supply is filled (see chapter 5.5 on page 14).

### 5.3.2 Filling the instant powder (option)

#### ATTENTION

#### Damage to the instant container cover!

The lid on the instant container cover cannot be removed. Trying to remove the lid could damage the cover. Only open the container cover with the machine key.

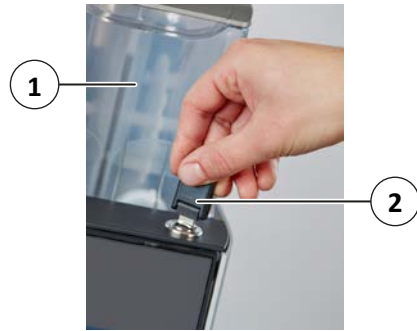

Fig. 9: Opening the instant container cover

000213

1. Open the machine door using the key (2).
2. Carefully lift the instant container cover (1) upwards.

There will be one or two instant containers depending on the equipment.



Fig. 10: Instant container

000147

3. Turn the powder chute (2) upwards so that no powder can fall out.
4. Remove the instant container (1).
5. Remove the lid on the instant container.
6. Fill the right instant powder into the corresponding container, e.g., cocoa.
  - Ensure that the powder is not compressed.
7. Re-fit the cover.
8. Re-fit the instant container.

9. Turn the powder chute downwards to direct it into the mixer housing.
10. Carefully fold the instant container cover downwards.
11. Close the machine door.

✓ The instant container has been filled.

### 5.3.3 Filling the milk (option)



Fig. 11: Filling the milk container

1. Open the door of the refrigerator.
2. Fill the milk container (1) with pre-cooled milk or prepare a container filled with pre-cooled milk.
3. Place the milk hose (2) into the container.
4. Close the door of the refrigerator.

✓ The milk supply has been filled.

### 5.4 Confirming filling levels

The filling level in the machine must be confirmed each time a supply container is filled.

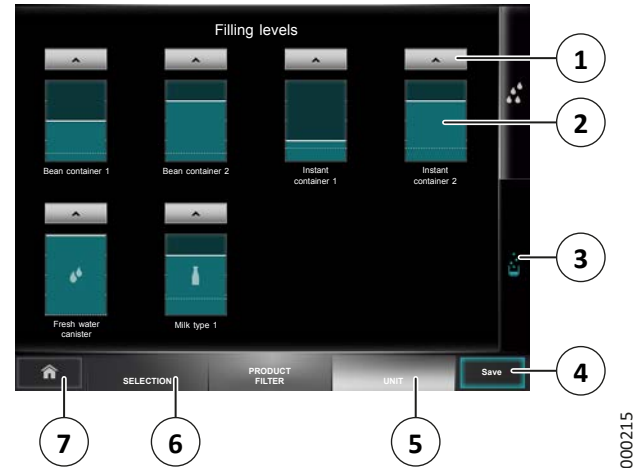

Fig. 12: Confirming filling levels

1. On the display, press the "Unit" button (5).
  - To use self-service operation, you must first log in with a chip key (see chapter 5.1.4 on page 10).
2. Press the "Filling levels" button (3).
3. Press the required "^" button (1) above the filling level displays to mark the following containers as full (from left to right and top to bottom):
  - Bean container 1 (front)
  - Bean container 2 (rear)
  - Instant container 1 (left)
  - Instant container 2 (right)
  - Fresh water canister
  - Milk type 1
4. Save your changes using the "Save" button (4).
  - Otherwise you will be prompted to confirm whether you want to reject the changes or go back to save the changes.

✓ The filling levels have been confirmed.

To return to the start screen, proceed as follows:

- **Self-service operation:** Press the "Home" button (7).
- **Waiter operation:** Press the "Selection" button (6).

This enables you to adjust the filling levels more accurately.

5. Press the required filling level display, e.g., the instant container 2 (2).
  - A new window opens.



Fig. 13: Adjusting filling levels more accurately



Fig. 14: Emptying the coffee grounds drawer

5

6. Select one of the following options:
    - Press the "^" button (1) to mark the container as full.
    - Touch the filling level display above or below the bar (2) to adjust the filling level on a step-by-step basis.
    - Slide the bar (2).
  7. Press the "Apply" (3) button to adopt the settings and return to the previous screen.
  8. Save your changes using the "Save" (4) button (see Fig. 12).
    - Otherwise you will be prompted to confirm whether you want to reject the changes or go back to save the changes.
- ✓ The filling levels have been confirmed.

If the filling level for a consumable drops below a set value while a product is being dispensed, a warning will appear on the display. If you confirm that the consumable has been refilled, you can then adjust the new filling level straight away in a similar dialog as shown in Fig. 13.

### 5.5 Emptying the coffee grounds drawer

The coffee grounds drawer must be emptied when the coffee grounds cannot be disposed of via the optional container ejection function.

When the coffee grounds drawer is almost full or full, the message is displayed that the grounds drawer must be emptied:

- If the coffee grounds drawer is 75 % full, only a few more brew processes can be carried out.
- If the coffee grounds drawer is 100 % full, only products that do not release coffee grounds can be dispensed. All other products are grayed out and cannot be selected.

1. Swivel the steam lance (2) (if present) forwards.
2. Pull the beverage outlet (1) fully upwards.
3. Open the coffee grounds door (3) by touching.
4. Pull out the coffee grounds drawer.
5. Empty the coffee grounds into the household waste.
6. Re-insert the coffee grounds drawer.
7. Close the coffee grounds drawer door (3).

If the coffee grounds drawer has been removed for longer than three seconds, a prompt to confirm whether or not the grounds drawer has been emptied appears after being re-inserted.

8. Confirm the prompt by pressing the "Yes" button.
- ✓ The coffee grounds drawer has been emptied.

### 5.6 Locking the product choice

You can lock product dispensing temporarily.

1. Hold the manager chip key on the contact area on the front of the machine.
  2. On the display, press the "Unit" button.
  3. On the display, press the "Lock product choice" button.
- ✓ The product choice is blocked.

To release product dispensing again, hold one of the chip keys on the contact surface on the front of the machine (see chapter 5.1.4 on page 10).



## 5.7 System messages

### 5.7.1 Messages in self-service operation

In self-service operation, system messages are indicated by a notice symbol (1).



Fig. 15: System messages

You can view the system messages by pressing the icon (1).

### 5.7.2 Messages in waiter operation

In waiter operation, system messages are displayed, for example if one of the products has run out (e.g., "Bean container empty"), directly on the display.

A notice symbol in the bottom left-hand button will then refer you to any system messages that have not been rectified. You can view the system messages by pressing the icon.

## 6 Dispensing products

### Note

Before dispensing products, all supply containers must be inserted and filled as otherwise no more products can be dispensed.

Once the machine has heated up, the products that can be dispensed are listed on the display. Products that are not available, e.g., due to a fault, are grayed out.

### CAUTION

#### Danger of burns due to hot products!

Contact with the product dispensed can result in burns.

- Do not reach underneath the outlets during operation.

### 6.1 Product dispensing

To dispense a product, press the corresponding product button on the display.



Fig. 16: Product dispensing in waiter operation

Groups and dispensing settings are labeled using the following icons:

- The "≡" icon identifies a product group (1).
  - Pressing this symbol opens the group.
- Pressing a product button with the "▶" icon dispenses the listed product (3) once.
- Pressing and holding a product button with the "o" icon dispenses the product (2) until contact is ceased.

You can select dispensing products sorted into groups by opening the specified group via touch to access the required product for dispensing.

### Product dispensing in waiter operation

After a product from a group has been dispensed, use the "Home" button (4) to return to the start screen, or wait for a short while until the start screen appears automatically.

### Product dispensing in self-service operation



Fig. 17: Product dispensing in self-service operation

Select your preferred display language by pressing the language selection field (1).

After a product from a group has been dispensed, use the "Home" button (2) to return to the start screen, or wait for a short while until the start screen appears automatically.

### 6.2 Canceling the product dispensing

Depending on the product preset, you can cancel the ongoing product output by pressing "X" during dispensing.

### 6.3 Dispensing coffee, coffee and milk, and milk products



Fig. 18: Dispensing products

1. Push the drink outlet (1) upwards so that the required cup fits underneath.
  2. Position the cups, pots, or glasses onto the drip grid (2).
  3. Move the beverage outlet downwards until just over the cup edge.
  4. Press the corresponding product button on the display.
- ✓ The product is dispensed.

### 6.4 Dispensing hot water (option)

- **Note**  
If there is no hot water lance fitted, hot water is also dispensed via the beverage outlet.



Fig. 19: Dispensing hot water

1. Position the cup underneath the hot water lance (1) on the drip grid (2).

2. Press the button on the display for dispensing hot water.

✓ The product is dispensed.

### 6.5 Dispensing steam (option)

**⚠ CAUTION**

**Danger of burns due to hot steam lance!**

Contact with the steam lance and steam can result in burns.

- Only grip the steam lance on the handle during operation.
- Do not touch the steam lance with bare hands when cleaning.



Fig. 20: Dispensing steam

1. Hold the cup for frothing milk underneath the steam lance (2).
  - Only grip the steam lance on the handle (1).
2. Press the button on the display for dispensing steam.
3. Remove the cup underneath the steam lance after frothing.
4. Then press the button for steam dispensing again to blow out the steam line.
5. Clean the steam lance from outside immediately with a clean and damp cloth to remove milk residues.

✓ The steam dispensing operation is complete.

### 6.6 Dispensing a double product

If this function is approved by customer service, you can request two portions of a coffee/milk product and fill two cups simultaneously.



Fig. 21: Dispensing a double product

1. Position a cup (2) in the center underneath each of the dispensing nozzles (1).
2. Press the corresponding product button on the display.

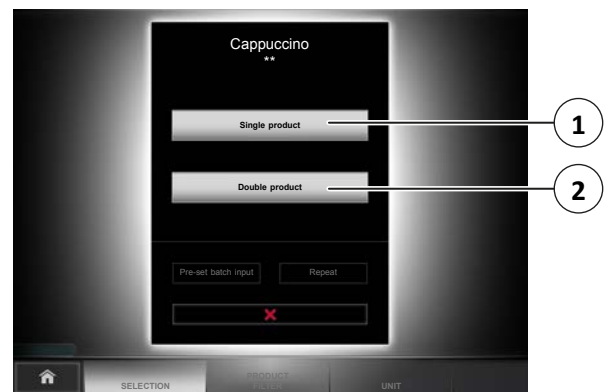

Fig. 22: Dispensing a double product

3. Select one of the following options:
  - Press the "Double product" button (2) to dispense two portions of the requested product.
  - Press the "Single product" button (1) to dispense a single portion of the requested product.



**Note**

If neither the "Double product" button nor the "Single product" button is pressed, a single portion of the requested product is dispensed after a short time.

✓ The product is dispensed.

### 6.7 Dispensing multiplier products

Under product settings (see chapter 7.6 on page 23), you can set up products as multiplier products. This means that you can issue multiple portions of a product in succession if necessary, for example to fill a larger cup.

#### Note

In order to dispense a multiplier product, there must be enough product material and capacity in the coffee grounds drawer.

1. Position a cup underneath the beverage outlet.
  2. Press the corresponding product button on the display.
    - While the product is being dispensed, the display shows how many single products are included in the multiplier product and which single product is currently being dispensed (e.g., "1 / 4", the first product of four single products).
    - The products are prepared and dispensed in succession.
- ✓ The dispensing of the multiplier product is complete.

### 6.8 Multiple dispensing of a single product

Multiple portions of a product can be requested as necessary and dispensed directly in sequence. The advantage of multiple dispensing is that you do not need to select the product again for every subsequent portion.

1. Position a cup underneath the beverage outlet.
  2. Press the corresponding product button on the display.
  3. While the product is being dispensed, press the "Repeat" button several times in succession depending on the number of additional portions that you would like to dispense.
    - The products are prepared and dispensed in succession.
  4. Once a portion has been dispensed, put the cup to one side and place another cup underneath the beverage outlet.
- ✓ The multiple dispensing operation is complete.

### 6.9 Batch mode

Batch mode can be used to preselect multiple products and dispense them in sequence.

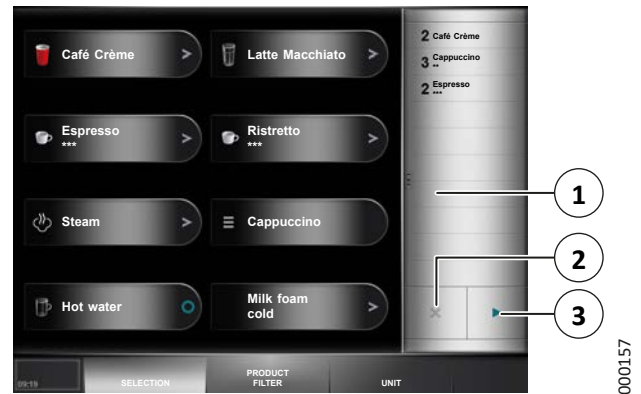

Fig. 23: Batch mode

Depending on the preset in the manager menu (see chapter 7.1 on page 20), the batch mode (1) can be switched on and off by default.

To switch the batch mode itself on or off, press the bar for the batch mode (1) on the right of the display.

#### Product dispensing in batch mode

1. With batch mode switched on, press the products to be dispensed in sequence.
2. Press the "▶" (3) button in the display to start dispensing the first product.
3. Once a product has been dispensed from the batch, remove it and position a suitable container for the next product underneath the corresponding beverage outlet.



Fig. 24: Product dispensing



4. Press the "▶" button (1) to continue dispensing the product.
    - Once all products from the batch have been dispensed, the machine returns to the start screen.
- ✓ The products have been dispensed and the batch mode is finished.

**Removing products in batch mode**

While products are being dispensed, you can remove products from the batch.

1. Press the "Pre-set batch input" button (2).
  2. Press the required product or the multiple selection of a product.
  3. Press the "X" button (2) (see Fig. 23) as follows:
    - Tap to delete a product.
    - Press and hold to delete this group from a multiple selection of a product.
- ✓ The product or multiple selection is removed from the batch.

**Adding products in batch mode**

While products are being dispensed, you can add products to the batch.

1. Press the "Pre-set batch input" button (2).
  2. Press the products to be dispensed in succession.
- ✓ The products are added to the batch.

**6.10 Product dispensing via product filter**

When dispensing products via the product filter, use various selection criteria to select the required product to be dispensed.

Depending on the preset in the manager menu (see chapter 7.1 on page 20), the following criteria are available:

Criteria	Dispense setting
Size	Portion size
Coffee	Products with/without coffee, with decaffeinated coffee, or with manual coffee addition
Milk type	Milk type or products without milk
Instant	With/without instant powder or corresponding instant powder
Syrup	With/without syrup (manual addition required)

Foam consistency	Mousse, normal, or firm milk foam
Foam temperature	Warm, normal, or hot milk foam
Heat milk	Products with heated or cold milk
Milk temperature levels	Warm or hot milk
Preparation	With milk or milk foam

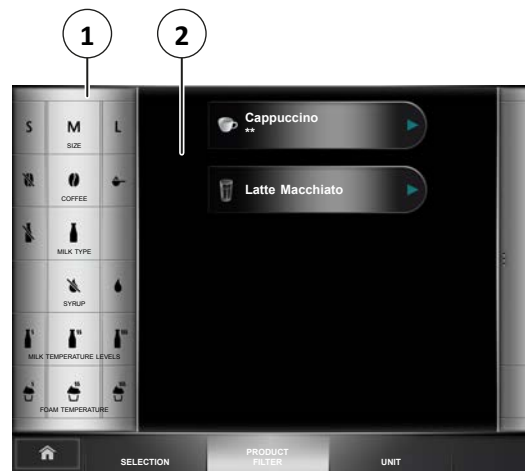

Fig. 25: Product dispensing via product filter

1. Select the required product to be dispensed using these criteria in the product filter (1).
    - Only products that match your criteria will be displayed. If multiple products meet your preselection options, these are displayed across multiple pages.
  2. Press the required product on the display (2) to dispense the product.
- ✓ The product is dispensed.

### 6.11 Preparing coffee from coffee powder

The manual coffee chute can be used to prepare coffee from coffee powder without removing beans from the bean container. This is normally used to prepare decaffeinated coffee. However, another type of coffee powder can normally also be added via the chute.



000145

Fig. 26: Filling coffee powder

1. Press the corresponding product button on the display for the product with manual coffee addition.
    - The prompt for the manual coffee addition is shown on the display.
  2. Open the flap (1).
  3. Add a heaped dosage spoon (approx. 8-9 g) of coffee powder via the chute.
    - Do not fill too much coffee powder into the chute. Otherwise the machine cancels the operation with an error message. The coffee powder is dispensed in the coffee grounds drawer.
  4. Close the flap (1).
  5. Confirm the filling process on the display.
- ✓ The coffee addition is confirmed and the product is dispensed.

## 7 Settings

The machine is preset to ensure that it is ready for immediate use for normal operation.

The functions described here are only accessible if enabled by customer service.

### 7.1 Opening the manager menu

The manager menu gives you access to advanced settings.

Button	Function
Selection	Activate products for dispensing, create/manage product groups (see chapter 7.4 on page 21)
Product filter	Edit selection criteria for the product filter in the waiter menu (see chapter 7.5 on page 23)
Product	Edit dispensed products (see chapter 7.6 on page 23)
Unit	Clean/switch off the machine and change the filling levels (see chapter 7.7 on page 24)
Operation	Set up the machine, show dispensing statistics, and display important events (see chapter 7.8 on page 25)



000160

Fig. 27: Manager menu

1. Hold the manager chip key on the contact area on the front of the machine.
- ✓ The display shows the manager menu.



## 7.2 Carrying out inputs

The machine allows you to enter designations and quantities via a screen keyboard.

When the screen keyboard appears on the display, you can use the following functions:



Fig. 28: Carrying out inputs

- Write using the letter/number field (2).
- Delete the entered characters (3).
- Save the input (4).
- Switch between upper and lower case (5).
- Cancel the input (1).

Some keys are also assigned with special characters (e.g., key "S"). Press the keys for a longer time to display the special characters.

## 7.3 Exiting the manager menu

1. Once you have carried out the required function, press the "Logout" button.
- ✓ The manager menu is closed.

## 7.4 Menu option "Selection"

Here you can select which pre-programmed products are displayed for dispensing.

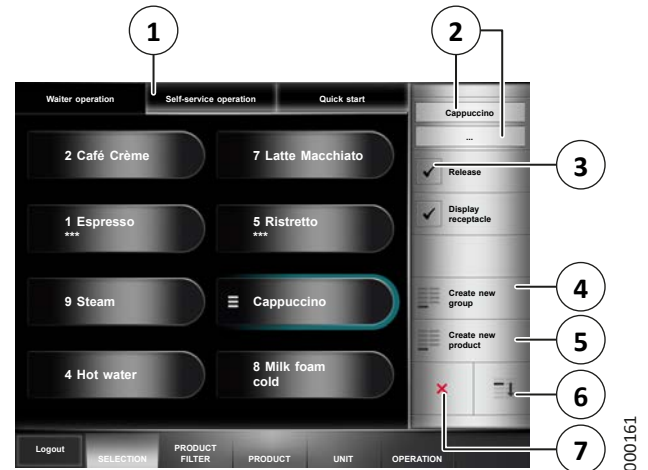

Fig. 29: Menu option "Selection"

For self-service and waiter operation, and for the quick start bar, you can manage or create different dispensing products and product groups. You therefore always need to start by selecting the operating mode (1) for which you would like to create, delete, or edit products or product groups.

### 7.4.1 Product groups

In self-service and waiter modes, you have the option to group related products together. This means you can display and output more than ten assigned products.

### 7.4.2 Creating product groups

1. On the display, press the "Create new group" button (4).
  - A new group appears on the display.
2. To name the group, press the button for the first or second line of the name (2).
  - A new window opens.

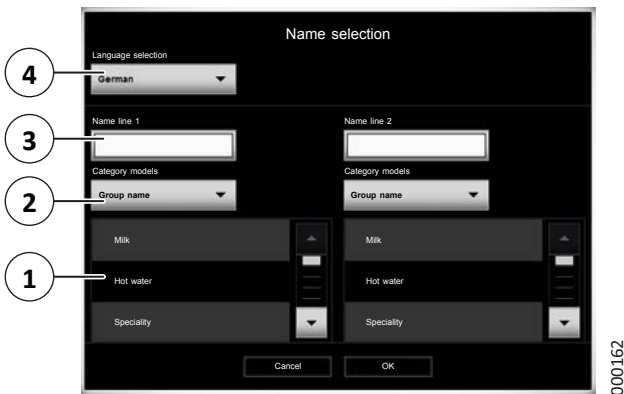

Fig. 30: Selecting or entering a name

3. Under "Language selection" (4), select the language that should be used for the name.
  - You can adjust the languages available for selection under the machine settings (see chapter 7.8.3 on page 26).
4. Select one of the following options to enter a name for the line in question:
  - Select a default name: Under "Category models" (2), select a category and then select a name (1).
  - Enter your own name: Press the corresponding line (3) and enter a name using the screen keyboard (see chapter 7.2 on page 21).
5. Confirm the name with the "OK" button.
6. Press the "Release" button (3) (see Fig. 29) to activate the created group for dispensing.
  - If you do not release the group, it will not be displayed on the dispensing interface.

✓ The new product group is created.

### 7.4.3 Deleting product groups

1. Press the required product group.
2. Press the "X" button (7) (see Fig. 29).
3. If prompted to confirm the deletion, press the "Delete" button to confirm the deletion.
  - Press the "Cancel" button to cancel the deletion.

► **Note**  
Only the display is cleared from the screen. The products remain stored on the machine.

✓ The product group is deleted.

### 7.4.4 Editing product groups

The following buttons can be used to edit a product group:

Button	Function
Release	Activate/deactivate the selected group for dispensing
Display receptacle	Show/hide the icon for the receptacle type in dispensing mode

### 7.4.5 Adding dispensing products

1. If you wish to add a dispensing product to a product group, open the required product group by pressing the icon twice.
2. Press the "Create new product" button (5) (see Fig. 29).
3. Select the required dispensing product from the product list.
4. Press the "Release" button (3) (see Fig. 29) to activate the created product for dispensing.
  - If you do not activate the product, it will not be displayed on the dispensing interface.

✓ The dispensing product has been added.

### 7.4.6 Deleting dispensing products

1. Press the required product.
2. Press the "X" button (7) (see Fig. 29).

► **Note**  
Only the display is cleared from the screen. The products remain stored on the machine.

✓ The dispensing product has been deleted.

### 7.4.7 Sorting dispensing products

1. Select the product by pressing on it.
2. Press the "Down" button (6) (see Fig. 29) to move the dispensing product downward.
3. Sort the dispensing products.
  - Start with the last dispensing product at the bottom and end with the first dispensing product at the top.

✓ The dispensing products have been sorted.

## 7.5 Menu option "Product filter"

Here you can set the selection criteria for filtering dispensing products available in waiter operation.

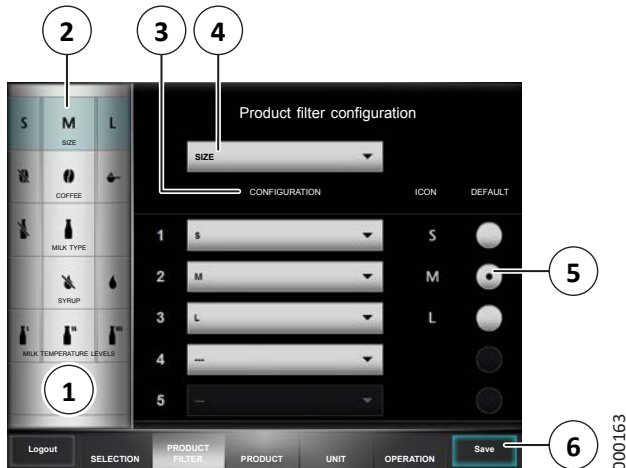

Fig. 31: Menu option "Product filter"

A list of all possible main criteria can be found in chapter 6.10 on page 19.

### 7.5.1 Adding main criterion

1. Press on an empty entry (1).
2. Select the required criterion (4).
  - If all possible criteria have already been added, it is not possible to add another criterion.
3. Add filters as described in chapter 7.5.3 on page 23.

✓ The main criterion has been added.

### 7.5.2 Deleting main criterion

1. Select the required main criterion (2).
2. Select the entry "---" (4).
3. Save your changes using the "Save" button (6).
  - Otherwise you will be prompted to confirm whether you want to reject the changes or you want to go back to save the changes.

✓ The main criterion has been deleted.

### 7.5.3 Editing main criteria

1. Select the required main criterion (2).
2. Use the buttons under "Configuration" (3) to select the filters you want to activate for pre-selection in waiter operation (e.g., no coffee component, coffee, decaffeinated coffee).
  - Selecting the entry "---" means that the filter is not activated in waiter operation.
3. Set the filter to be preselected by default (5) (e.g., Coffee).
4. Save your changes using the "Save" button (6).
  - Otherwise you will be prompted to confirm whether you want to reject the changes or you want to go back to save the changes.

✓ The main criterion has been edited.

## 7.6 Menu option "Product"

Here you can change the values for product components, if approved by customer services.

### 7.6.1 Changing products

1. Select the "Product" menu to display a list of all products.
2. Use the "▲" and "▼" buttons to move the list to display all the programmed products.
3. Press on a product to edit it.
4. Use the "▲" and "▼" buttons to scroll through the various settings options.
5. Select the component to be changed (e.g., Coffee variety) or the value to be changed (e.g., Article number).
6. Change the values for the product using the screen keyboard.



#### Note

Products identified with a \* in the ID cannot be edited. These products are pre-programmed in the basic settings for the machine.

7. Save your changes using the "Save" button.
  - Otherwise you will be prompted to confirm whether you want to reject the changes or you want to go back to save the changes.

✓ The values of the product components are changed.

### 7.6.2 Duplicating a product

You can duplicate an existing product and then use it as a basis for a new product.

1. Select the required product from the product list.

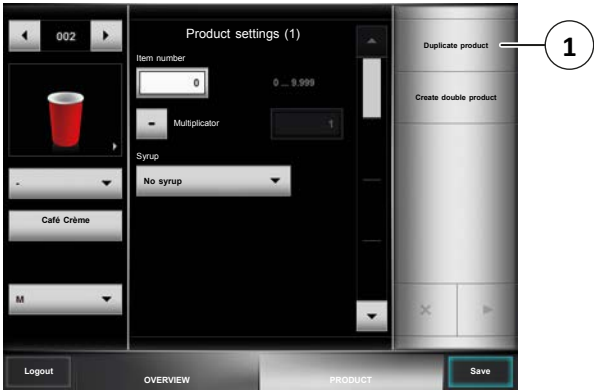

Fig. 32: Duplicating a product

2. Press the button (1).
  - The question "Duplicate product?" appears on the display.
3. Confirm the question with "Duplicate".

You can now change the various components in the duplicated product. Proceed as described in chapter 7.6.1 on page 23.

4. Save your changes using the "Save" button.
  - Otherwise you will be prompted to confirm whether you want to reject the changes or you want to go back to save the changes.

✓ The product is duplicated.

### 7.7 Menu option "Unit"

Here you have the option of adjusting the filling levels, cleaning the machine, or switching it off.

#### 7.7.1 Menu option "Filling levels"

As well as confirming the filling levels, as described in chapter 5.4 on page 13, you can also make further settings on the filling levels in the manager menu.

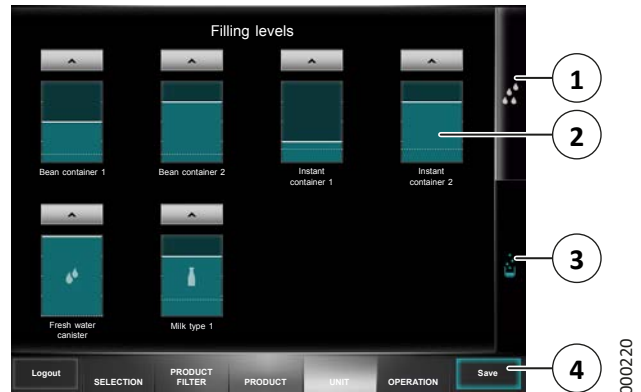

Fig. 33: Filling levels

1. Press the "Filling levels" button (3).
2. Press the required filling level display, e.g., the instant container 2 (2).
  - A new window opens.



Fig. 34: Further filling settings

3. The "Designation" button (2) can be used to change the name of the container.

If the filling level for a consumable drops below a set value while a product is being dispensed, a warning will appear on the display.

4. The "Limit value" button (1) is used to set a percentage at which a warning is issued for the filling level.
  - Enter the number "zero" to switch this warning off.
5. Press the "Apply" (3) button to adopt the settings and return to the previous screen.
6. Save your changes using the "Save" (4) button (see Fig. 33).
  - Otherwise you will be prompted to confirm whether you want to reject the changes or you want to go back to save the changes.

✓ The filling settings have been changed.

### 7.7.2 Menu option "Maintenance"

Here you have the option of cleaning the machine or switching it off.

1. Press the "Maintenance" button (1) (see Fig. 33).

A time until the next clean and the time of the next prompt for cleaning are shown on the display.

2. Carry out the required option:

► **Note**  
For hygiene reasons, the machine must always be cleaned before switching off.

The "Switch off" function is only permitted to be used if a cleaning process has been carried out and no further products have been dispensed.

Option	Options
Clean touch screen	Clean the touch screen when the display is locked, see chapter 8.9 on page 34
Clean full system	Clean the milk and brewing system, then continue machine operation, see chapter 8.6 on page 29
Clean and switch off full system	Clean the milk and brewing system, then switch off the machine, see chapter 5.2.3 on page 11
Lock product choice	Lock product dispensing temporarily, see chapter 5.6 on page 14
Switch off	Switch off the machine

✓ The selected option is carried out.

## 7.8 Menu option "Operation"

Here you can read off the consumption and product statistics and adjust settings for the machine.

### 7.8.1 Opening usage statistics



Fig. 35: Usage statistics

1. Press the "Usage statistics" button (1) to open the usage statistics for ground coffee and instant powder.
  2. Press the line containing the statistics symbol (2) to view statistics on the weight of sample and brew duration.
    - Select the corresponding grinder and product.
    - You can use the filter to display statistics according to various criteria.
- ✓ Usage statistics are opened.

000165

### 7.8.2 Opening product statistics

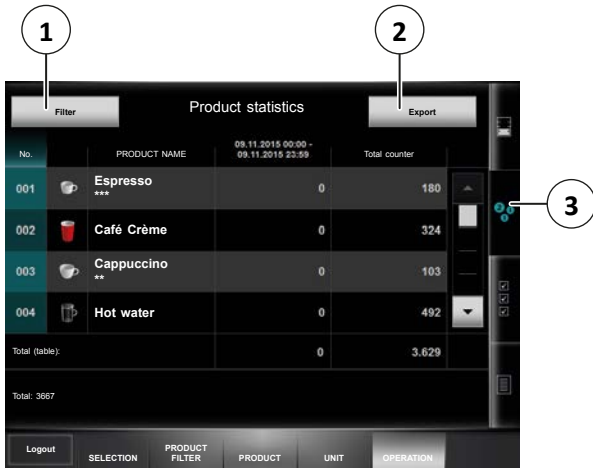

Fig. 36: Product statistics

1. Press the "Product statistics" button (3) to see how many times a product has been dispensed.
2. Use the "▲" and "▼" buttons to move the list to display all the programmed products.
3. Press the "Filter" (1) button to display products according to various criteria.

✓ The product statistics are opened.

You can export the product statistics list to a USB stick, e.g., to process them for further use. You can store the exported data in CSV format on the USB stick's root directory.

4. Open the machine door using the key.



Fig. 37: Inserting the USB stick

5. Slide the cover inside the machine door (1) to the side.
6. Insert a suitable USB stick (2) into the USB slot.
  - Not every USB stick is suitable for use. The machine door must be able to close when the USB stick is inserted.

7. Close the machine door.
8. Press the "Export" button (2) (see Fig. 36).
9. Select one of the following options:
  - Press the "Filtered" button to only export the displayed, filtered section of the product statistics.
  - Press the "All" button to export the entire product statistics list.
10. Open the machine door.
11. Remove the USB stick and slide the cover back.
12. Close the machine door.

✓ The product statistics list is exported.

### 7.8.3 Machine settings

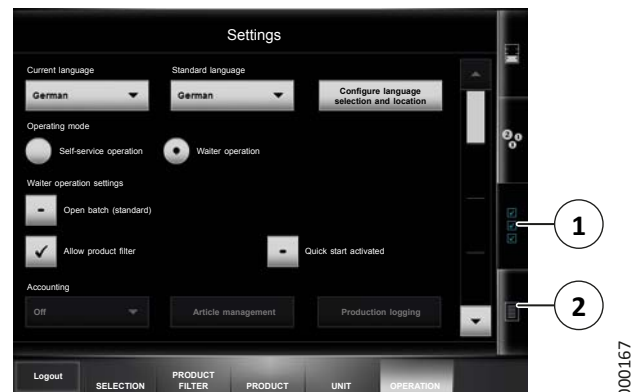

Fig. 38: Machine settings

1. Press the "Settings" button (1) to display and edit the basic settings for the machine.
2. Use the "▲" and "▼" buttons to move the list to show all the settings options:

Button	Settings
Current language	Set the display language.
Standard language	Language to be displayed by default in self-service operation. If a different language has been set, this language will be displayed again after five minutes without any input.
Configure language selection and location	Select the languages for "Current language" and "Standard language" and set the location (country).
Operating mode	Set the default mode for the machine: Self-service or waiter operation.





Waiter operation settings	In waiter operation, set whether or not the batch processing should be opened by default, whether or not the product filter is available, and whether the quick start bar is displayed.
Accounting	If an accounting system is connected, adjust settings for the accounting process. You can choose between "Off", "Normal billing", and "Free operation".
Date	Set the current date using the screen keyboard.
Time	Set the current time using the screen keyboard.
Summer time	Choose between the settings "Automatic" and "No".
Cleaning time	Adjust 1 <sup>st</sup> and 2 <sup>nd</sup> cleaning time for the automatic cleaning prompt in the display. If there is only one cleaning time, 1 <sup>st</sup> and 2 <sup>nd</sup> cleaning time must be identical.
Display brightness	Set display brightness.
Display brightness (standby)	Set the display brightness for stand-by mode.
Output lighting	Set the brightness for the output lighting.
Front light color	Set the color of the front lights.
User interface	Select the visual style of the display from various templates.
Screensaver	Select the screensaver.
User-defined localization	Adjust the decimal point and the thousands separator, the time and date format, or currency symbol to local requirements.

#### 7.8.4 Logging

- Press the "Logging" button (2) (see Fig. 38) to display important events or error messages on the machine.
    - You can use the filter to display events according to various criteria.
- ✓ The log is displayed.

- Save your changes using the "Save" button.
    - Otherwise you will be prompted to confirm whether you want to reject the changes or you want to go back to save the changes.
- ✓ The machine settings have been changed.

## 8 Cleaning

Clean the coffee machine carefully in accordance with the following specifications to maintain the value and hygiene of the machine.

- **Note**  
The following website provides all specific information on the machine and cleaning agents:  
[www.planerhandbuch.de](http://www.planerhandbuch.de)

### 8.1 Safety measures

**⚠ DANGER**

**Risk of fatal electric shock!**

Contact with live parts poses a danger of death.

- Never open covers unless explicitly instructed to do so.
- Never remove bolts and the housing parts that they hold in place.
- Do not clean the machine or the installation area of the machine with a water jet, high-pressure cleaner, or steam cleaner.
- Never pour water over the machine.
- Only clean the machine with a damp cloth.

**ATTENTION**

**Machine damage!**

Water penetration can damage the machine and cause a short circuit.

- Do not clean the machine or the installation area of the machine with a water jet, high-pressure cleaner, or steam cleaner.
- Never pour water over the machine.
- Only clean the machine with a damp cloth.

### 8.2 Cleaning intervals

Interval	Which parts?	How to clean
After every use	Steam lance	Emit steam for approx. 2 seconds. Then clean with a clean, damp cloth.
Daily <sup>(1)</sup>	Milk and brewing system	Start cleaning program.
Daily	Instant system	Clean.
Daily	Coffee grounds drawer	Clean.
Daily	All systems/parts that have been used at least once	Clean with a clean, damp cloth.
1x weekly	Bottom of the beverage outlet	Clean with a clean, damp cloth; use a damp brush if necessary.
Following an extended standstill	Milk and brewing system	Start cleaning program.
As required (at least once a month)	Bean and instant containers	Clean.
As required (at least once a month)	Housing parts <ul style="list-style-type: none"> <li>• Surfaces, plastic parts, painted surfaces</li> </ul>	Clean externally with a clean, damp cloth.

<sup>(1)</sup> Twice a day for heavier use (more than 20 l of milk or more than 150 coffee products).

### 8.3 Cleaning prompt and dispensing lock

If cleaning is required (e.g., one of the programmed cleaning times has been exceeded), the cleaning prompt appears on the display. Products can then only be dispensed for a limited time or number of products.

If no cleaning work is carried out, product dispensing is then locked. The products are no longer displayed and cannot be dispensed.

To reset the cleaning prompt or dispensing lock, the machine must be cleaned.



## 8.4 Cleaning agent

Only use the cleaning agents listed as these are best suited to the automatic cleaning program:

- Coffee cleaning tabs (art. no. 24718)
- Milk cleaner liquid concentrate (RFM) (art. no. 24720)

### ⚠ CAUTION

#### Damage to health due to cleaning agents!

The components in the cleaning agent may irritate eyes and skin, and be harmful to health if inhaled or swallowed.

- Always keep cleaning agents out of the reach of children.
- Only use the cleaning agents listed in the instructions, otherwise the legal warranty will become void.
- Wear gloves.
- Observe warning notes on the cleaning agent containers.
- Observe the recommended usage quantity.

## 8.5 When using canisters

1. Empty both canisters daily.
  - Do not leave any water residue in the canisters; even fresh water quickly becomes contaminated.
2. Also observe the limit values for water carbonate hardness during canister operation.
  - Where necessary, the fresh water supply must be topped up via a water filter (e.g., BRITA-Purity).
3. Before filling, clean the fresh water canister and its cover area with standard dishwashing agent and rinse the cleaner residues thoroughly.
4. Also clean the waste water tank daily with detergent to prevent unpleasant odors forming due to organic waste in the waste water.
5. Clean the filter sieve in the fresh water canister as necessary (at least once a month).
  - The filter housing is located on the inside of the lid.
  - Unscrew the narrow housing cap on the bottom end of the filter housing with the FEP tube and rinse the mesh insert.
6. Ensure that the fresh water canister is filled with sufficient water and that the waste water canister is empty before you start the cleaning program.

## 8.6 Daily cleaning

No products can be dispensed during the cleaning process. Product dispensing can be continued only after the cleaning program has been ended and all containers have been re-fitted.

### 8.6.1 Cleaning the coffee grounds drawer

The coffee grounds drawer must be cleaned when the coffee grounds cannot be disposed of via the optional container ejection function.

1. Empty the coffee grounds drawer as described in chapter 5.5 on page 14.
2. Clean the coffee grounds drawer.
  - Rinse the coffee grounds drawer with water.
  - Dishwasher cleaning is possible at max. 60 °C.
3. Wipe the insert compartment of the coffee grounds drawer with a damp cleaning cloth.
4. Re-insert the coffee grounds drawer.
5. Follow the instructions on the display.

- ✓ The coffee grounds drawer has been cleaned.

### 8.6.2 Running the cleaning program

#### ⚠ CAUTION

#### Danger of burns!

There is a danger of burns from hot components or due to hot liquids.

- Do not hold any body parts underneath the beverage outlet while the cleaning program is running or during the rinsing processes.
- Note that the water in the drip tray may be hot.

#### Preparatory activities (option)

The preparatory activities only have to be carried out when a milk system is present and has been used.

1. Damp-clean the milk tube coming out of the machine.
2. Clean the inside of the refrigerator (if fitted), the door, and door seals with a conventional cleaner.
  - Leave the door open during the entire cleaning process. Otherwise, condensation could form and impair functioning.



Fig. 39: Cleaning container

000221

3. Replace the milk container with the empty cleaning container (1).

**Starting the cleaning program**

The machine cleaning program normally runs automatically.

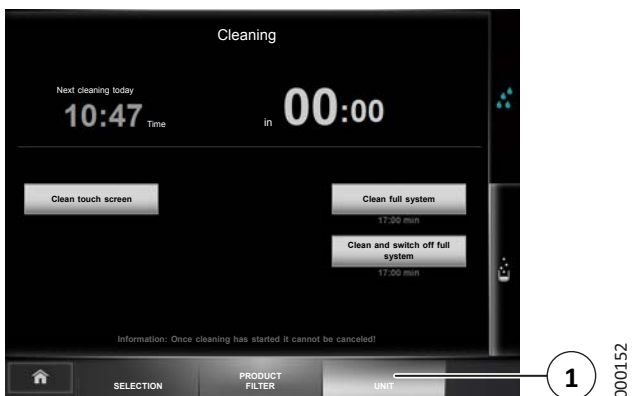

Fig. 40: Starting the cleaning program

000152

1. On the display, press the "Unit" button (1).
  - To use self-service operation, you must first log in with a chip key (see chapter 5.1.4 on page 10).
2. Select one of the following options:

Button	Function
Clean full system	Clean the milk and brewing system, then continue machine operation
Clean and switch off full system	Clean the milk and brewing system, then the machine switches off

If prompted to clean the instant system first, complete this process first (see chapter 8.6.3 on page 31) and then confirm that it has been fully re-installed.

3. First press "Instant system is cleaned" and then "Instant system installed".

**Clean milk system (option)**

The prompt "Cleaning agent milk system" is shown on the display.



Fig. 41: Metering chamber of the RFM cleaner

000222

1. Create a cleaning solution.
  - Mix ½ liter (500 ml) of cold water with 25 ml of the RFM cleaner (1).
2. Fill the cleaning container with the prepared cleaning solution.
3. Fit the milk hose into the cleaning container.
  - Make sure that the milk hose touches the bottom of the cleaning container.
4. Use the "Cleaning agent was added" button to confirm that the cleaning agent has been prepared.
  - This cleans the milk system.

After rinsing, the "Prepare rinsing" prompt is displayed.

**CAUTION**

**Health risk!**

Cleaning residue could be harmful to health.

- The milk system must be rinsed with clean water.

5. Empty the container with the cleaning solution and rinse out the container.
6. Pour ½ liter (500 ml) of clear water into the container.
7. Insert the milk hose into the water.
  - Make sure that the milk hose touches the bottom of the cleaning container.
8. Confirm the prompt with the "Rinsing prepared" button.
  - The milk system is then rinsed with clean water.

### Cleaning the brewing system

The question "Cleaning agent brewing system" is shown on the display.



Fig. 42: Cleaning tablet

000120

1. Open the flap (1).
2. Place a cleaning tablet into the chute.
3. Close the flap (1).
4. Use the "Cleaning tablet is inserted" button to confirm that a cleaning tablet has been inserted.
  - The brewing system begins with the automatic cleaning.
  - The cleaning process takes a few minutes.

The machine is then switched off or depending on the selection, it goes back to operational readiness mode.

### Final activities

1. Clean the dispensing area once the automatic cleaning process is complete (see chapter 8.10 on page 34).
  2. If you want to continue using the machine, refill the milk as described in chapter 5.3.3 on page 13.
- ✓ The milk and brewing system has been cleaned.

### 8.6.3 Cleaning the instant system

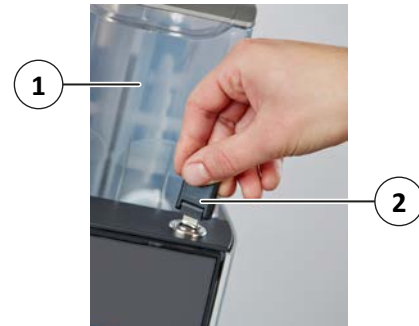

Fig. 43: Opening the instant container cover

000213

1. Open the machine door using the key (2).
2. Carefully lift the instant container cover (1) upwards.
3. Carry out the steps as described below.

There will be one or two instant containers depending on the equipment.

### Removing the mixer unit

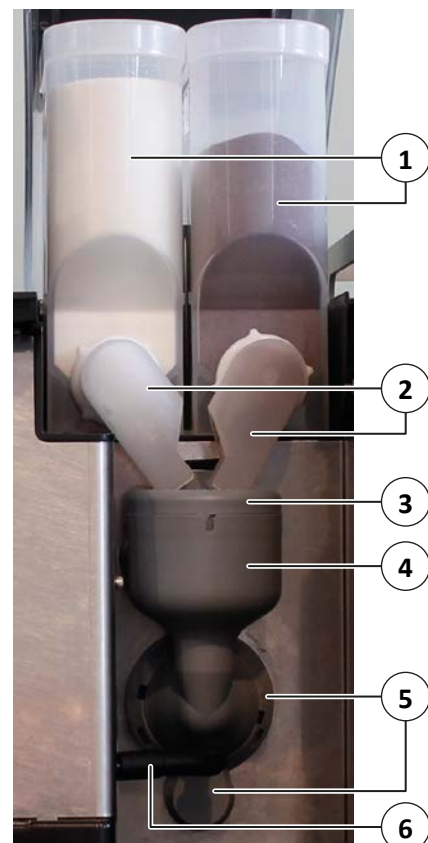

Fig. 44: Mixer unit

000174

1. Turn the powder chute (2) upwards so that no powder can fall out.
2. Remove the instant container (1).
3. Remove the powder chute (2).

4. Repeat stages 1 to 3 for the second instant container if necessary.
5. Remove the hose (6) on the mixer unit and on the beverage outlet.
6. Turn the mixer flange (5) counterclockwise until the arrow is on the "lock open" icon.
7. Remove the entire mixer housing (4) to the front.
8. Remove the cover (3).

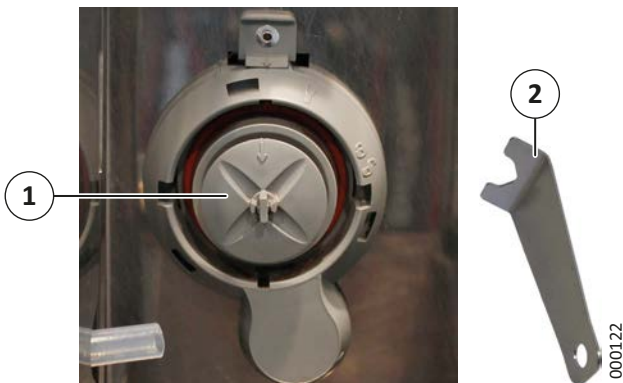

Fig. 45: Removing the mixer impeller

9. Remove the mixer impeller (1) from the axle either by hand or using the removal tool (2) provided.

✓ The mixer unit has been removed.

### Cleaning the mixer unit

1. Remove rough dirt with water and a brush.
2. To clean the mixer unit, proceed with one of the following options:
  - Clean the parts in a dishwasher at a maximum of 60 °C.
  - Clean all parts thoroughly with hot water and a cleaner suitable for milk products.
    - Rinse all parts thoroughly with clean water.
3. Dry the parts completely.
  - To prevent the instant powder from forming clumps, the parts must be absolutely dry.
4. Damp-clean the area around the axle.
  - This is the area where the mixer impeller is located.

✓ The mixer unit has been cleaned.

### Assembling the mixer unit

Assembly is carried out by reversing the order of the removal process.

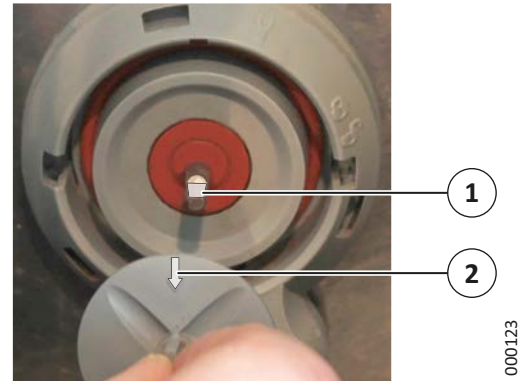

Fig. 46: Fitting the mixer impeller

1. Insert the mixer impeller onto the axle as far as it will go.
  - Note that the flattened side (1) matches up with the arrow (2) on the mixer impeller.

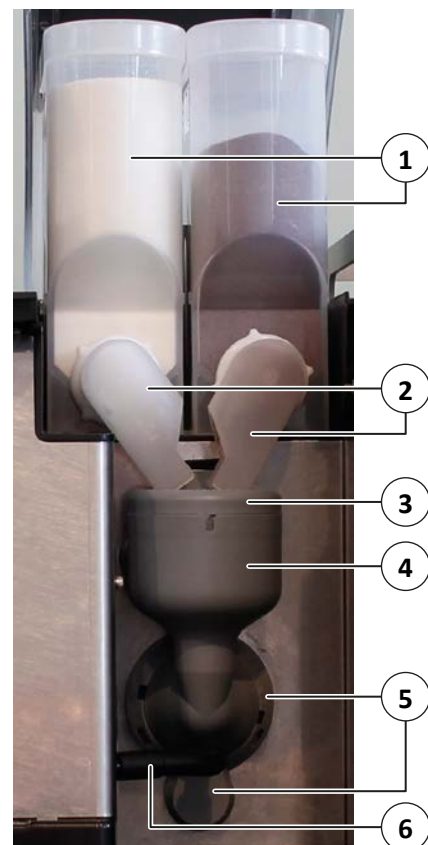

Fig. 47: Mixer unit

2. Re-fit the cover (3).
3. Fit the mixer housing (4).
4. Turn the mixer flange (5) clockwise until the arrow is pointing to the "closed lock" icon.



5. Fit the hose (6) fully onto the nozzle of the mixer unit and the beverage outlet.
  - Check that the hose is fitted securely.
6. Fit the powder chute (2) so that it is pointing upwards.
  - Do not reach into the cleaned powder chute with your fingers.
7. Fit the instant container (1) onto the machine.
8. Turn the powder chute downwards to direct it into the mixer housing.
9. Repeat stages 6 to 8 for the second instant container if necessary.

✓ The mixer unit has been installed.

### 8.7 Cleaning the bean container

There will be one or two bean containers depending on the equipment.



Fig. 48: Removing the bean container

1. Remove the cover on the bean container.
2. Turn the lever (1) a  $\frac{1}{4}$  turn counterclockwise.
3. Remove the bean container (2).
4. Empty the bean container.
5. Clean all parts thoroughly with hot water and a rinsing agent.
  - Dishwasher cleaning is possible at max. 60 °C.
6. Dry the parts completely.
7. If you want to continue using the machine, refill the beans as described in chapter 5.3.1 on page 11.

✓ The bean container has been cleaned.

### 8.8 Cleaning the instant container

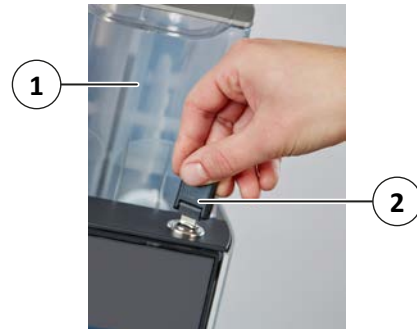

Fig. 49: Opening the instant container cover

1. Open the machine door using the key (2).
2. Carefully lift the instant container cover (1) upwards.

There will be one or two instant containers depending on the equipment.



Fig. 50: Instant container

3. Turn the powder chute (2) upwards so that no powder can fall out.
4. Remove the instant container (1).
5. Empty the instant container.
6. Clean all parts thoroughly with hot water and a rinsing agent.
  - Dishwasher cleaning is possible at max. 60 °C.
7. Dry the parts completely.
  - To prevent the instant powder from forming clumps, the parts must be absolutely dry.
8. If you want to continue using the machine, refill the instant powder as described in chapter 5.3.2 on page 12.

✓ The instant container has been cleaned.

### 8.9 Cleaning the touch screen

Cleaning is required if there is any visible dirt.

1. On the display, press the "Unit" button.
  - To use self-service operation, you must first log in with a chip key (see chapter 5.1.4 on page 10).
2. Press the "Clean touch screen" button.
  - The display is now blocked for inputs.
3. Clean the screen with a microfiber cloth or a damp cloth.
  - If you use a damp cloth, make sure that the touch screen is completely dry and free of streaks before you continue using the unit.
4. After cleaning, unlock the display for inputs again by touching the numbers 1-4 in the corners of the display.

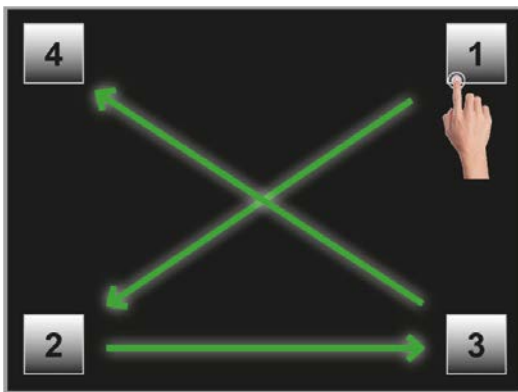

Fig. 51: Cleaning the touch screen

- ✓ The touch screen has been cleaned.

### 8.10 External cleaning



#### Note

Do not use any abrasive agents or sharp objects.

- Clean the parts with a clean, damp cloth only.
1. Wipe down the plastic parts, painted surfaces and surfaces with a damp cloth.



Fig. 52: External cleaning

2. Remove the drip grid (3).

#### ▲ CAUTION

#### Risk of scalding!

The water in the drip tray may still be hot.

- Allow the water to cool down.
3. Wipe the drip tray (1) thoroughly.
  4. Clean the bottom of the beverage outlet (2) thoroughly with a clean, damp cloth, and a standard, damp brush if necessary.

- ✓ The outside of the machine is clean.



## 9 Maintenance

If you have any questions concerning service, maintenance or disposal, please contact your official dealer. Repairs and maintenance may only be carried out by Melitta customer service or by specialist personnel authorized by the manufacturer.

### 9.1 Intervals

After every 30,000 cups or twelve months of operation (whichever occurs first), the machine and all accessory units must be serviced by the customer service team (for a fee).

- Ensure that the maintenance work date is scheduled well in advance to avoid unnecessary wear.
- Observe the intervals for changing the filter given in the manufacturer's instructions.
- Replace the water filter every twelve months at the latest to prevent germs and water contamination.

On request, the manufacturer offers a comprehensive maintenance contract that also ensures that all inspection and maintenance intervals are observed.

By law, commercial operators are required to have their systems inspected by an authorized electrical engineer once every four years to make sure that everything is in order. These inspections must be performed and documented accordingly.

Customer service can take care of this for you and certify that everything has been completed correctly (no other inspection is required prior to initial commissioning).

### 9.2 Faults

In the event of faults, have the unit inspected and, where applicable, repaired by customer service before you start using it again. Repair work performed incorrectly can result in considerable risk to the user.

#### **▲ WARNING**

#### **Malfunctions!**

If there are visible signs of damage or any obvious malfunctions, some key safety functions might not work properly.

Obvious malfunctions include water leaks, odors and heat formation, as well as error messages on the display. In the event of a malfunction:

- Disconnect the mains plug.
- Switch off the water supply.
- Have the machine checked and serviced by customer service.

## 10 Recycling and disposal

This machine has been designed and manufactured to allow environmentally friendly disposal.

### 10.1 Waste disposal

The waste produced during brewing is purely organic and as a result can be disposed of in normal household waste.

### 10.2 Waste water disposal

The waste water produced during the brewing and cleaning processes complies with the definitions of general domestic waste water and is therefore permitted to drain into the normal sewerage system.

### 10.3 Disposal of cleaning agents

The cleaning agents recommended in these instructions conform to legal requirements when used correctly and for this reason are permitted to drain into the normal sewerage system with the rinse water without further measures.

### 10.4 Disposal of the machine

This machine contains high-quality raw materials that should be recycled.



**Do not dispose of equipment in domestic waste!**

During disposal, observe the appropriate national and regional laws and guidelines.

**Melitta macht Kaffee zum Genuss<sup>®</sup>**



Melitta Professional Coffee Solutions GmbH & Co. KG • Zechenstr. 60 • 32429 Minden • GERMANY  
Phone: +49 571 5049-0 • Fax: +49 571 5049-233 • professional@melitta.de • www.melitta-professional.de