

OSCAR II



SERVICE MANUAL



MACHINE DESCRIPTION	1
FIRST INSTALLATION AND PRELIMINARY OPERATIONS	2
REMOVAL OF THE EXTERNAL SURFACE	3
INFUSION UNIT	4
HEATER	5
HYDRAULIC CIRCUIT	6
ELECTRIC COMPONENTS	7
TROUBLESHOOTING	8
DIAGRAMS	9
MAINTENANCE CHECKING	10
SPARE PART CATALOGUE	11

INDEX

1. MACHINE DESCRIPTION	1.1
1.1 DESCRIPTION	1.2
1.2 KEYBOARD DESCRIPTION (Standard configuration).	1.3
1.3 SAFETY REGULATIONS	1.4
1.4 MACHINE IDENTIFICATION	1.7
1.5 TRANSPORT	1.8
1.5.1 HANDLING	1.8
2. FIRST INSTALLATION AND PRELIMINARY OPERATIONS	2.1
2.1 FIRST INSTALLATION	2.2
2.1.1 WEIGHT AND DIMENSIONS.	2.2
2.1.2 CONNECTION TO THE WATERLINE AND DRAINAGE SYSTEM	2.3
2.1.3 TECHNICAL SPECIFICATIONS.	2.4
2.1.4 CONNECTION TO THE POWER LINE	2.4
2.1.5 PROCEDURE OF FIRST INSTALLATION.	2.4
2.2 ACCESSORIES BOX	2.5
2.2.1 FITTING THE FILTER HOLDER.	2.5
2.3 PROGRAMMING DOSES	2.6
3. REMOVAL OF THE EXTERNAL SURFACE	3.1
3.1 REMOVAL OF WATER TANK	3.2
3.2 REMOVAL OF THE CUP HOLDER SURFACE.	3.3
3.3 REMOVAL OF THE SIDE PANELS	3.4
3.4 REMOVAL OF THE REAR PANEL	3.4
3.5 TANK TO COLLECT WATER FILED	3.4
3.6 REMOVAL OF THE FRONT PANEL	3.5
3.6.1 REMOVAL OF KEYBOARD	3.6
4. INFUSION UNIT	4.1
4.1 REMOVAL OF SHOWER AND SEAL	4.2
4.2 COFFEE VALVE	4.3
4.3 EXPANSION VALVE	4.5
5. HEATER	5.1
5.1 EMPTYING THE HEATER	5.2
5.2 REMOVAL OF THE HEATER.	5.4
5.3 HEATING ELEMENT AND HEAT PROTECTION	5.5
5.4 REPLACEMENT OF THE LEVEL GAUGE.	5.6
5.5 ANTIVACUUM VALVE	5.7
5.6 SAFETY VALVE	5.8
6. HYDRAULIC CIRCUIT	6.1
6.1 PUMP DISASSEMBLY	6.2
6.2 REPLACING THE COFFEE VALVE	6.4
6.3 STEAM NOZZLE	6.6
6.4 WATER TANK.	6.11
6.4.1 REPLACEMENT OF THE FLOAT.	6.11
6.4.2 REMOVAL OF THE MAGNETIC SENSOR.	6.12
6.5 REMOVAL OF THE PRESSURE SWITCH	6.12
7. ELECTRIC COMPONENTS	7.1
7.1 CONTROL UNIT.	7.2
8. TROUBLESHOOTING.	8.1
8.1 WATER LACK LIGHT.	8.2
8.2 HEATING ELEMENT LIGHT	8.3
8.4 COFFEE DELIVERY	8.4
8.5 STEAM DELIVERY.	8.4
8.6 HEATER	8.5
9. DIAGRAMS	9.1
9.1 HYDRAULIC DIAGRAM TANK VERSION	9.2
9.2 HYDRAULIC DIAGRAM DIRECT CONNECTION VERSION	9.3
9.3 WIRING DIAGRAM TANK VERSION.	9.4
9.4 WIRING DIAGRAM DIRECT CONNECTION VERSION.	9.5
10. MAINTENANCE CHECKING	10.1
10.1 DAILY MAINTENANCE	10.2
10.2 WEEKLY MAINTENANCE	10.2
10.3 YEARLY MAINTENANCE	10.3
10.4 BIENNIAL MAINTENANCE	10.4
11. SPARE PART CATALOGUE	11.1
11.1 CABINET PARTS	11.2
11.2 COMPLETE POURING UNIT	11.3
11.3 TANK - FRAME COMPONENTS.	11.4
11.4 STOVE FILED COLLECT WATER.	11.5
11.5 BOILER COMPONENTS	11.6
11.6 ELECTRICAL COMPONENTS	11.7

1. MACHINE DESCRIPTION



INDEX

1. MACHINE DESCRIPTION	1.1
1.1 DESCRIPTION	1.2
1.2 KEYBOARD DESCRIPTION (Standard configuration)	1.3
1.3 SAFETY REGULATIONS	1.4
1.4 MACHINE IDENTIFICATION	1.7
1.5 TRANSPORT	1.8
1.5.1 HANDLING	1.8

1.1 DESCRIPTION

Fig. 1



LEGEND

- 1 Steam lever
- 2 Cup warming grill
- 3 Water reservoir
- 4 Water reservoir hatch
- 5 Main switch
- 6 Dispensing unit
- 7 Water drain tank
- 8 Cup support grill
- 9 Filter holder
- 10 Steam wand
- 11 Steam wand insulating rubber
- 12 Control panel

1.2 CONTROL PANEL DESCRIPTION (Configuration standard)

Fig. 2



LEGEND

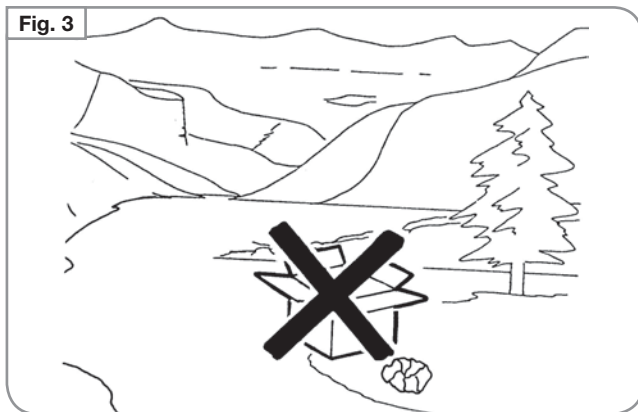
- 1 Water level warning light
- 2 Heating resistance on warning light
- 3 Two coffee dispensing button / programming entry
- 4 One coffee dispensing button / Standby

1.3 SAFETY INDICATIONS

The present manual is an integral and essential part of the product and is to be delivered to the user. Carefully read all warnings in the manual as they provide important information required to install, use and maintain the unit safely. Keep this manual in a safe place for further consultation.

After having removed the packaging, make certain that the unit is not damaged in any way.

If you have any doubts, do not use the unit and contact a professionally qualified person. Always keep all packaging (plastic bags, polystyrene foam, nails, etc..) out of the reach of children as they are a potential source of danger and never loiter the environment with such materials.



The machine is can be installed in staff kitchen areas in shops, offices and other working environments, farm houses by clients in hotels, motels and other residential type environments bed and breakfast type environments.

Before turning on the unit make certain that the rating indicated on the label matches the available power supply. The nameplate can be seen inside the machine when removing the water collection tray. The machine must be installed according to the applicable federal, state and local standards (codes) in force with regard to plumbing systems including backflow prevention devices. For this reason, the plumbing connections must be carried out by a qualified technician.

The warranty expires if the characteristics of the power supply do not correspond to the nameplate data.

The manufacturer cannot be held responsible for any damages incurred if the system is not grounded.

For electrical safety, this machine requires a ground system. Contact a technically certified electrician who must check that the line electrical capacity is adequate for the maximum capacity indicated on the unit label.



The qualified electrician must also check that the section of the installation's cables is large enough for the absorbed power of the appliance.

Never use adapters, multiple jacks or extension cords. When such items prove absolutely necessary, call in a qualified electrician.

When installing the device, it is necessary to use the parts and materials supplied with the device itself. Should it be necessary to use other parts, the installation engineer needs to check their suitability for use in contact with water for human consumption. The installer must Make the hydraulic connections respecting the rules of hygiene and water safety to environmental protection in force in the place of installation. So for the hydraulic plant contact an authorized technician. Always utilise the new hose supplied for connection to the water supply. Old hoses must not be utilised.

The device needs to be supplied with water that is suitable for human consumption and compliant with the regulations in force in the place of installation. The installation engineer needs confirmation from the owner/manager of the system that the water complies with the requirements and standards stated above.

This unit must only be used for the purposes described in the present manual. The manufacturer cannot be held responsible for any damages caused by improper, mistaken and unreasonable use.

The appliance is not to be used by children or persons with reduced physical, sensory or mental capabilities, or lack of experience and knowledge, or lack of experience and knowledge, unless they have been given supervision or instruction. Children must not play with the appliance. Cleaning and maintenance must not be carried out by children unless supervised.

This appliance is for professional use only.

The operating temperature must be within the range of $[+5, +35]^{\circ}\text{C}$.

At the end of installation, the device is switched on and taken to rated operating conditions, leaving it in a state in which it is "ready for operation".

After reaching the "ready for operation" condition, the following dispensing operations are carried out:

- 100% of the coffee circuit through the coffee dispenser (for more than one dispenser, this is divided equally);
- Open the steam outlet for 1 minute.

At the end of installation, it is good practice to draw up a report of the operations.



CAUTION

Before using the machine, read this manual in its entirety or, at the very least, read the safety and set up instructions.

There are some basic rules for the use of any electrical appliance.

In particular:

- Never touch the unit with wet hands or feet;
- Never use the unit with bare feet;
- Never use extension cords in areas equipped with baths or showers;
- Never pull on the power supply cord to unplug the unit;
- Never leave the unit exposed to atmospheric agents (rain, direct sunlight, etc.);
- Never let children, unauthorized personnel or anyone who has not read this manual operate the unit.

Before performing any sort of maintenance, the authorized technician must turn off the unit and unplug it from the mains.

Fig. 5

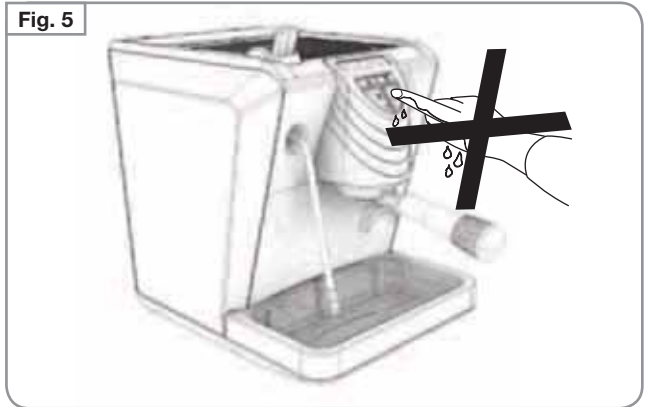
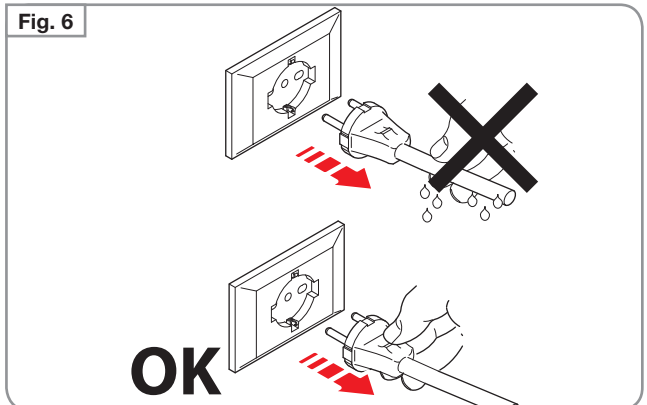


Fig. 6



Before cleaning the unit set it in a state of "0" energy: that is, "MACHINE SWITCHED OFF AND UNPLUGGED". Follow the instructions given in this manual carefully.

Refer to chapters 6 and 7 for periodical cleaning and maintenance. The authorized technician must, before carrying out any maintenance, disconnect the plug after the switch off of the machine.

In case of breakdown or poor function, turn off the unit. Never tamper with the unit. Contact only professionally qualified personnel.

Only the manufacturer or an authorized service center can make repairs and only using original spare parts.

Non compliance with the above can compromise machine safety.

On installation, the qualified electrician must fit a circuit breaker switch as foreseen by the safety norms in force that has a contact open distance that permits the complete disconnection under conditions of overload category III.

To prevent dangerous overheating, it is advisable to fully extend the power supply cord.

Never block the intake and/or heat dissipation grills, in particular those for the cup warmer.

Fig. 7

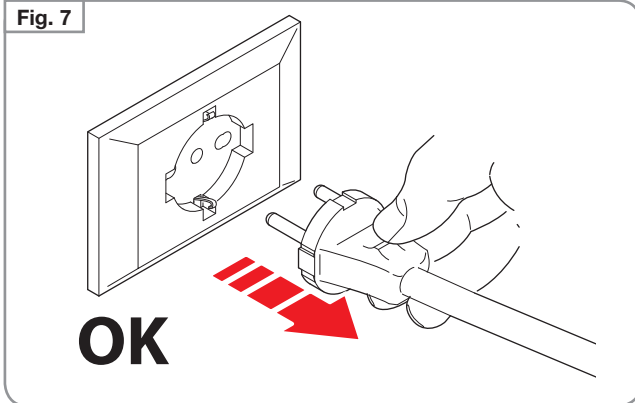
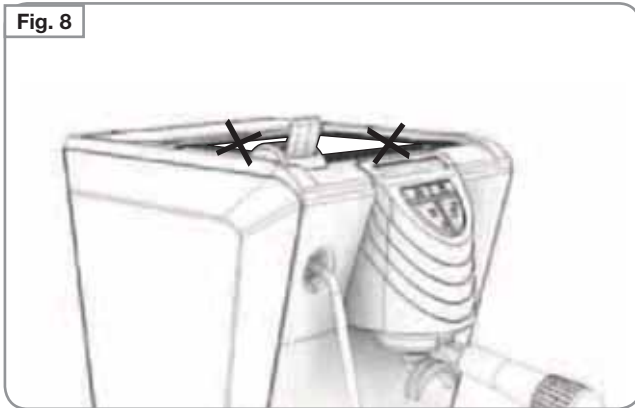


Fig. 8



The user must never replace the unit's power supply cord. If this cord is damaged, turn off the unit and have it replaced by a professionally qualified technician.

Should it be necessary to replace the power cord, this replacement operation must only be performed by an authorized service centre or by the manufacturer.

Should you decide to stop using this type of unit, we suggest you render it inoperable by unplugging it and cutting the power supply cord.

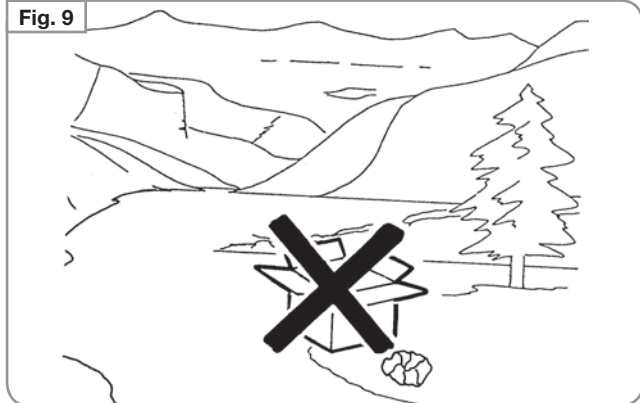
Do not throw the machine in nature for the Elimination contact an authorized center or contact the manufacturer who will provide you the necessary information about it.

Never dispose of the machine in the environment: to dispose of the machine, contact an authorized center or contact the manufacturer for pertinent indications.



WARNING
DANGER OF POLLUTION

Fig. 9



DANGER OF INTOXICATION

Once started the washing machine, do not interrupt, the detergent residue may remain inside the delivery unit.



CAUTION
DANGER OF BURNS

Fig. 10



To facilitate aeration of the unit, position the aeration portion of the machine 15 cm from walls or other machinery.

Be extremely careful when using the steam nozzle. Never place your hands under the nozzle and never touch it right after use.

Remember that to install, maintain, unload and regulate the unit, the qualified operator must always wear work gloves and safety shoes.

When adding the coffee, the operator must never put his hands into the container.

The noise level of the machine is less than 70db.

For machines connected to the mains water supply, the minimum pressure must be 2 bar and the maximum pressure for correct machine operation must not exceed 4 bar.

 **CAUTION**



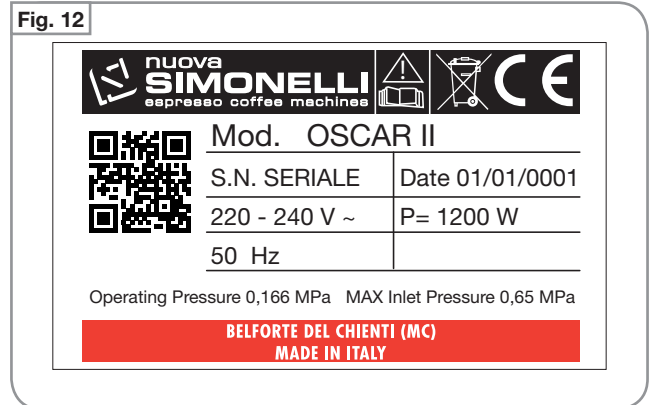
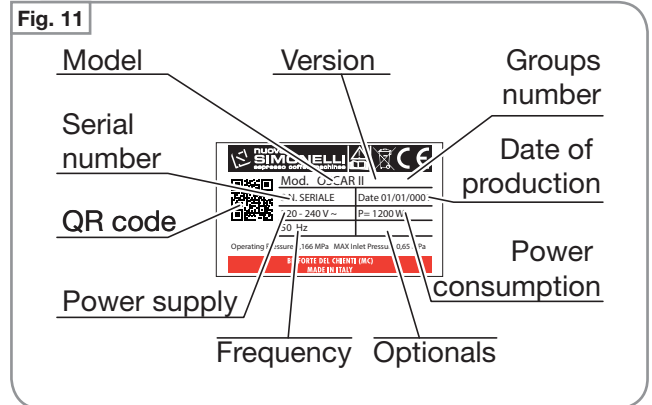
INFORMATION TO THE USERS
Under the senses of art. 13 of Law Decree 25th July 2005, n. 151 "Implementation of the Directives/Guidelines 2002/95/CE, 2002/96/CE and 2003/108/CE, concerning the reduction of the use of dangerous substances in electric and electronic equipment, as well as the disposal of wastes".

The symbol of the crossed large rubbish container that is present on the machine points out that the product at the end of its life cycle must be collected separately from the other wastes. The user for this reason will have to give the equipment that got to its life cycle to the suitable separate waste collection centres of electronic and electro-technical wastes, or to give it back to the seller or dealer when buying a new equipment of equivalent type, in terms of one to one.

The suitable separate waste collection for the following sending of the disused equipment to recycling, the dealing or handling and compatible environment disposal contributes to avoid possible negative effects on the environment and on the people's health and helps the recycling of the materials the machine is composed of. The user's illegal disposal of the product implies the application of administrative fines as stated in Law Decree n.22/1997" (article 50 and followings of the Law Decree n.22/1997).

1.4 MACHINE IDENTIFICATION

Always quote the machine serial number in all communications to the manufacturer, **Nuova Simonelli**.



The machine internet page can be accessed directly through the QR code.

By downloading and installing one of the apps to read such codes on a mobile device. Start the app and position the camera in front of the code so that it can be clearly seen. Wait some time while the app processes the result and shows the internet page of the machine on the display.

1.5 TRANSPORT

The machine is transported on pallets which also contain other machines - all boxed and secured to the pallet with supports.

Before carrying out any transport or handling operation, the operator must:

- put on work gloves and protective footwear, as well as a set of overalls which must be elasticated at the wrists and ankles.

The pallet must be transported using a suitable means for lifting (e.g., forklift).

1.5.1 HANDLING



WARNING
COLLISION OR CRUSHING HAZARD

During the entire handling operation, the operator must make sure no one or nothing is inside the operating area.

Slowly lift the pallet to about 30 cm from the ground and move to the loading area. After making sure there are no obstacles, persons or things, proceed with loading.

Once at destination, always using an adequate lifting mechanism (e.g. fork-lift), after making sure there is no one or nothing within the unloading area, lower the pallet to about 30 cm from the ground and transport it to the storage area.



WARNING
COLLISION OR CRUSHING HAZARD

Before performing the following operation, make sure the load is in place and is not likely to fall when the straps are cut.

The operator, wearing safety gloves and footwear, must now cut the straps and store the product. To perform this operation, check the technical characteristics of the product to determine the weight of the machine to be stored and take consequent precautions.

2. FIRST INSTALLATION AND PRELIMINARY OPERATIONS

INDEX

2. FIRST INSTALLATION AND PRELIMINARY OPERATIONS	2.1
2.1 FIRST INSTALLATION	2.2
2.1.1 WEIGHT AND DIMENSIONS	2.2
2.1.2 CONNECTION TO THE WATERLINE AND DRAINAGE SYSTEM	2.3
2.1.3 TECHNICAL SPECIFICATIONS	2.4
2.1.4 CONNECTION TO THE POWER LINE	2.4
2.1.5 PROCEDURE OF FIRST INSTALLATION	2.4
2.2 ACCESSORIES BOX	2.5
2.2.1 FITTING THE FILTER HOLDER	2.5
2.3 PROGRAMMING DOSES	2.6

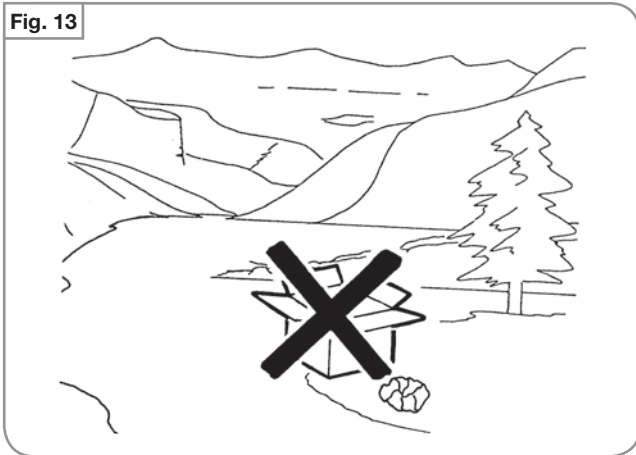


RISK OF POLLUTION

DO NOT DISPOSE PACKAGING in the environment.

Prior to installation please carefully read the safety instructions in this manual. The company cannot be held responsible for damage to persons or property arising from non-compliance with safety regulations, either during installation or maintenance of the machine described in this manual.

Fig. 13



WARNING

Place the machine in an area where all risks of malfunction can be avoided.



WARNING

Never install in areas where the machine may be subject to jets of water.

2.1 FIRST INSTALLATION

2.1.1 WEIGHT AND DIMENSIONS

NET WEIGHT	14 kg	31 lb
GROSS WEIGHT	17 kg	37 lb
POWER	1200 W	1200 W
DIMENSIONS		



2.1.2 CONNECTION TO THE WATERLINE AND DRAINAGE SYSTEM

The machine requires stringent specifications to prevent the formation of limescale and to ensure quality beverages. The main features required to achieve high standards of performance are the following:

Total hardness	50 -60 ppm
Waterline pressure	2-4 bar, cold water
Minimum flow	200 l/hr
Filtration	Less than 1.0 micron
Alkalinity	10-150 ppm
Total dissolved salts (TDS)	50 -100 mg/L
Chloride	< 0.5 mg/L
pH	6.5- 8.5

It is the task of a qualified technician to:

- 1 Adapt the water from the waterline to the specifications required using filters and water softeners;
- 2 Train the final user so that the equipment for water treatment is constantly kept perfectly operational.

The version with direct coupling is provided with a loading tube 1,5 meters long with a 3/4 inch. On one side the fitting is straight and tapered, the other angled at 90° with a gasket. The tube is provided with tapered fittings therefore it is not necessary to use Teflon tape on the fitting.

To connect the machine to the waterline, proceed as follows:

- 1 Remove the pipe from the upper door "A" and connect one of its ends to fitting "B" situated on machine base.
- 2 Connect the other end of the pipe to the waterline using a 3/8 fitting.



NOTE

Dirty water drainage is carried out through the drip tray both for version with connection to the waterline and with tank.



WARNING

If the water features do not comply, the warranty will automatically expire.

2.1.3 TECHNICAL SPECIFICATIONS

The machine is available in the following versions:

- single-phase 120 V 60 Hz (tank and waterline)
- single-phase 230 V 50 Hz (tank and waterline)
- single-phase 230 V 60 Hz (waterline)

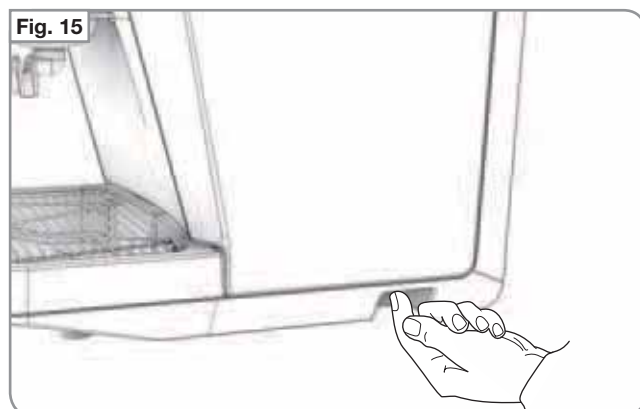
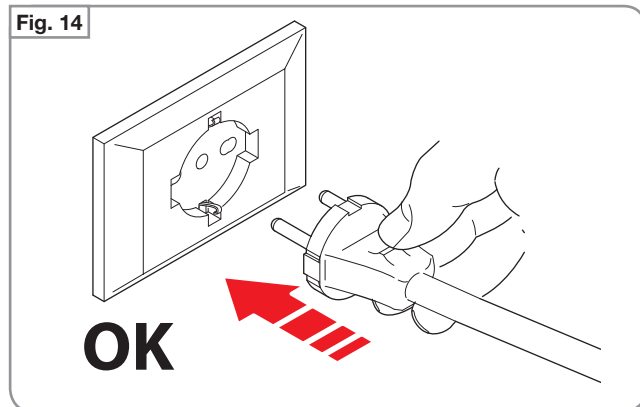
The relative power absorbed is indicated on the machine plate.

2.1.4 CONNECTION TO THE POWER LINE

Before utilising the machine, the operator must have read and fully understood the safety instructions in this manual.

Connect the machine to the power socket.

The machine carries out the following checks.



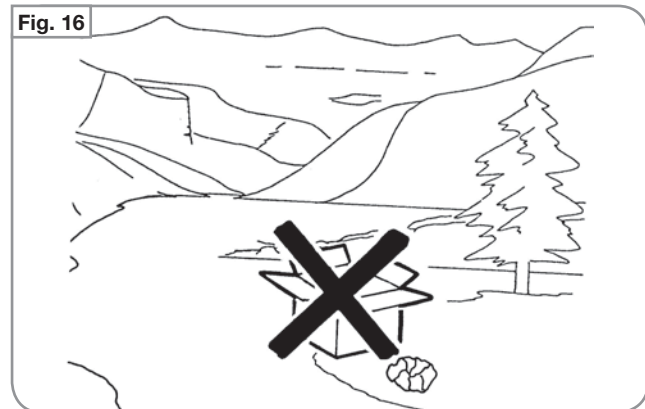
2.1.5 PROCEDURE OF FIRST INSTALLATION

Before carrying out the installation carefully read the safety instructions at the beginning of this manual and particularly about how to put THE MACHINE INTO ZERO ENERGY STATUS.

1 Once the machine has been removed from the packaging, position it on a horizontal surface and proceed with the installation as illustrated in the following paragraphs.

Arrange the accessories as follows:

- 2** Insert the ring in its seat inside the filter holder.
- 3** Insert one of the two filters.
- 4** Caution: danger of pollution.



Tank Model:

- 5** Open the hatch and take out the reservoir. Especially the first time, wash the reservoir with soap and water. Fill the reservoir with water and make certain that the outside of the reservoir is dry.
- 6** Return the reservoir to its housing and close the hatch.
- 7** Make certain that the water drain tank has been inserted.



If the machine does not have enough water in the tank or the pump stays on for more than 90 seconds, the machine will stop and all the buttons flash. Getting on and off the machine: operation of the filling boiler will run until the appropriate level.

**NOTE**

In the absence of load water at first boot:

- 1 Could be created air bubble between the pump and reservoir and is preventing the passage of water.
- 2 Make sure that the tank valve is working.
- 3 Remove and replace the tank filled with water several times to facilitate removal of the air bubble.

Direct attachment version:

- 5 Open the door of the tank and remove the hose for direct attachment.
- 6 Connect the hose to the water supply and open the tap upstream of the machine if present.
- 7 Make certain that the water drain tank has been inserted.

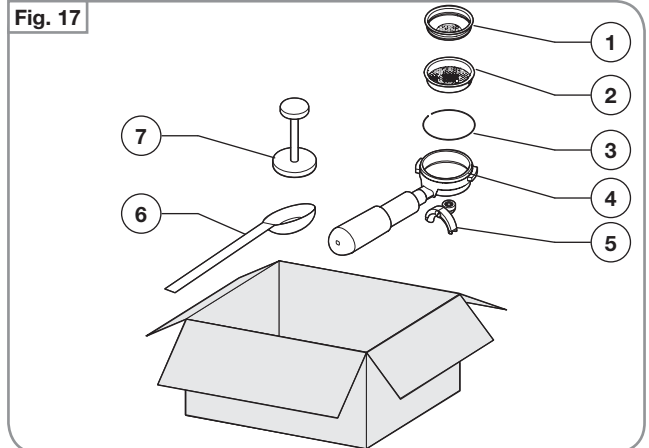
Make certain that the cup support grill is positioned squarely and is level:

- 8 Check that the steam lever is closed.
- 9 Make certain that the line voltage corresponds to the requirements indicated on the label.
- 10 The preliminary operations have been completed and the machine is ready to be set up.

2.2 ACCESSORIES BOX

Machine is supplied with an accessories box consisting of:

- 1 Single filter
- 2 Double filter
- 3 Spring
- 4 Filter holder
- 5 Dispensing nozzle
- 6 Coffee doser

**2.2.1 FITTING THE FILTER HOLDER**

To properly mount the filter holder:

- 1 Insert the spring inside the pay slot inside the filter holder.
- 2 After selecting the appropriate filter (1 or 2), insert the filter in the filter holder until you hear the snap with spring.
- 3 Screw the dispensing spout up to place it perpendicular to the handle.

**NOTE**

To change the filter inserted, pry up the edge with one of the other filters.


2.3 PROGRAMMING DOSES

Carry out the following operations to enter into programming mode:



NOTE

Operation to be carried out with the machine switched on.

To enter into programming mode, press the  two coffee dispensing buttons for 5 seconds. The dispensing buttons start to flash.



NOTE

After 30 seconds of inactivity (no buttons pressed) in programming mode, the machine returns to normal mode and no data is memorised.

PROGRAMMING COFFEE DOSES

To programme the dose of water relative to one of the



dispensing buttons, proceed as follows:

Fill the filter holder with the correct dose of coffee (the filter holder can be single or double depending on the button to be programmed).

Place the filter holder into the unit.

Press one of the dispensing buttons.



Dispensing starts; once the desired quantity has been reached press the same button again.



To exit from the programming mode and memorise

the desired doses, keep the  button pressed for at least 5 seconds; the buttons stop flashing.

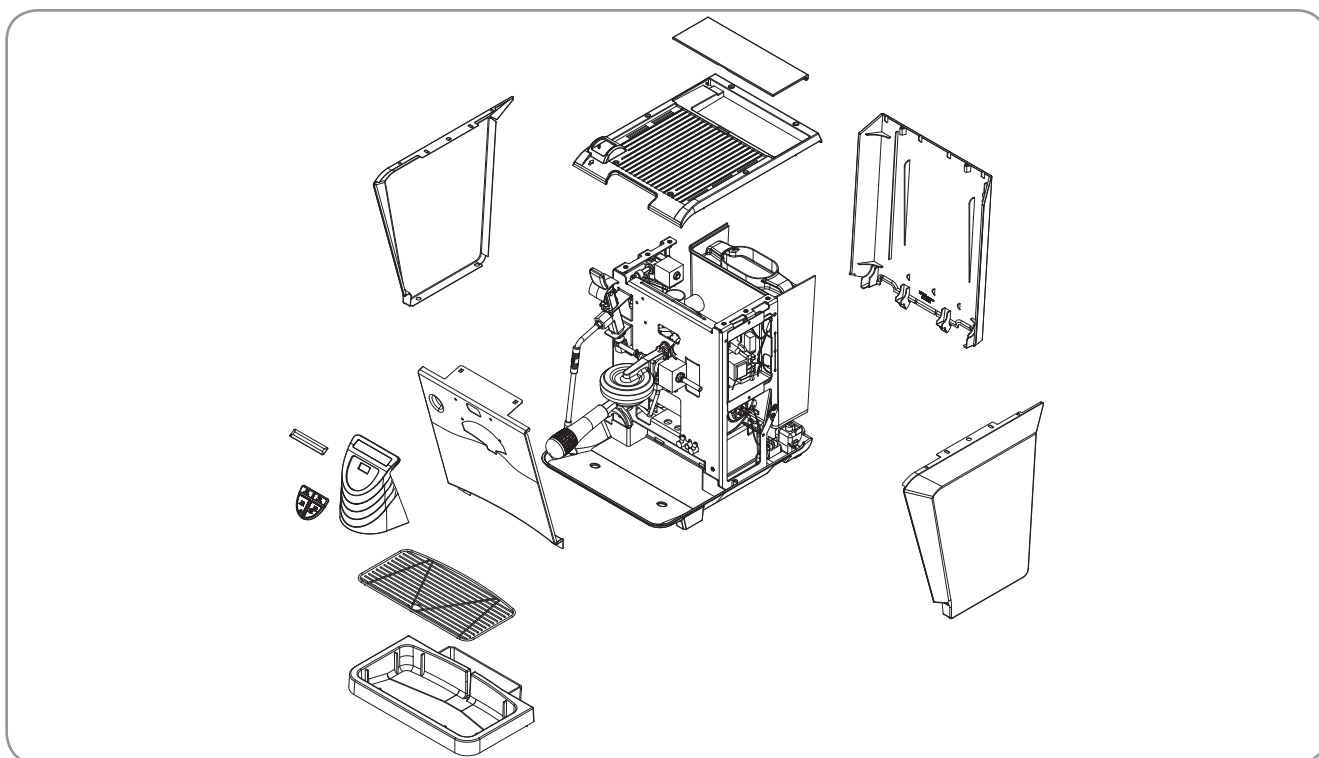
Fig. 18



Fig. 19



3. REMOVAL OF THE EXTERNAL SURFACE



INDEX

3. REMOVAL OF THE EXTERNAL SURFACE	3.1
3.1 REMOVAL OF WATER TANK	3.2
3.2 REMOVAL OF THE CUP HOLDER SURFACE	3.3
3.3 REMOVAL OF THE SIDE PANELS	3.4
3.4 REMOVAL OF THE REAR PANEL	3.4
3.5 TANK TO COLLECT WATER FILLED	3.4
3.6 REMOVAL OF THE FRONT PANEL	3.5
3.6.1 REMOVAL OF KEYBOARD	3.6

TOOLS NEEDED:





DANGER

Use gloves to protect against sharp or hot surfaces that you can bump against involuntarily during operations.



NOTE

Before proceeding with the removal of the panels it is advisable to clean and free up enough space where the machine parts will rest so that they are not be unintentionally damaged.



DANGER

Before proceeding with the operations described in the chapter make sure that the machine is turned off and unplugged from the mains. Discharge any residual pressure present in the heater.

3.1 REMOVAL OF WATER TANK

To remove machine covers, take out the water tank first:



NOTE

This operation is necessary only for the version with tank.

To remove the tank from its seat, proceed as follows:

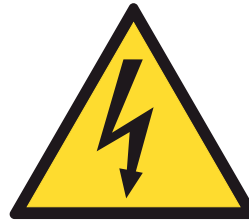
- 1 Lift the water tank cap.

Fig. 22



**CUTTING
AND
HOT
SURFACES**

Fig. 23



DANGER

Fig. 22



- 2 Pull the water tank upward.

3.2 REMOVAL OF THE CUP HOLDER SURFACE

To remove the bearing surface of the cup, proceed as follows:

- 1 Unscrew the screws "A" with a screwdriver.

- 2 Lift the panel and pull upwards.

Fig. 23**Fig. 24****Fig. 25**

3.3 REMOVAL OF THE SIDE PANELS



NOTE

To remove the side panels, it is necessary to remove the cup holding surface first.

- 1 Unscrew the "A" present on each panel using a Phillips screwdriver.

Fig. 26



- 2 Move outside the top of the panel and pull up.



NOTE

Perform the same steps for the other side panel.

Fig. 27



3.4 REMOVAL OF THE REAR PANEL



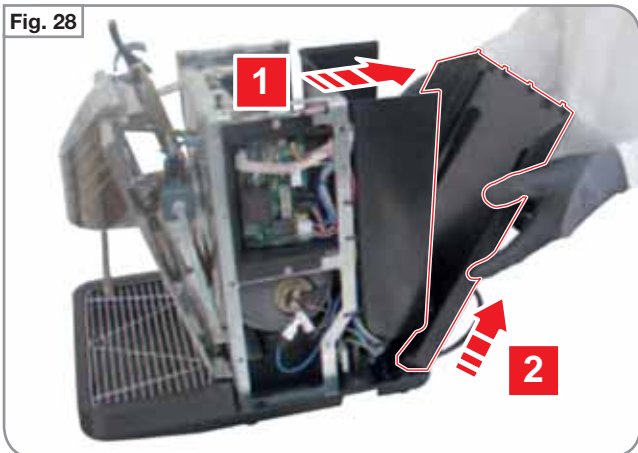
NOTE

To remove the back panel it is necessary to remove both side panels first.

Proceed as follows:

- 1 Move outside the top of the panel and pull up.

Fig. 28



3.5 TANK TO COLLECT WATER FILED

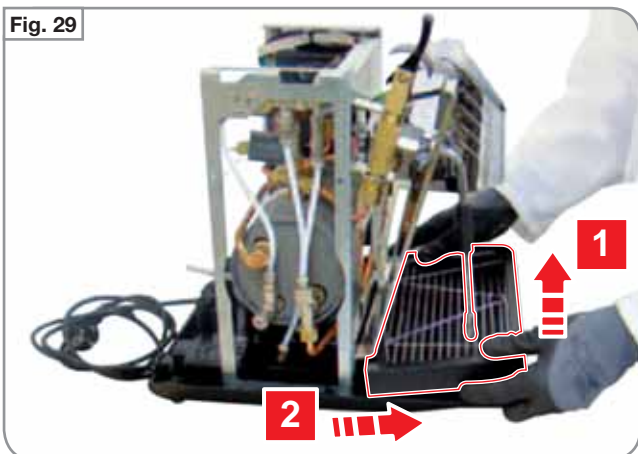


NOTE

To remove the tray with water you need:

- 1 Lift and remove the tray with water.

Fig. 29



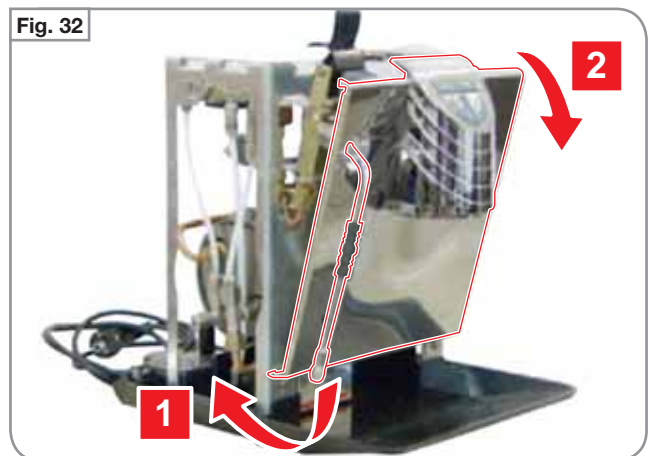
3.6 REMOVAL OF THE FRONT PANEL



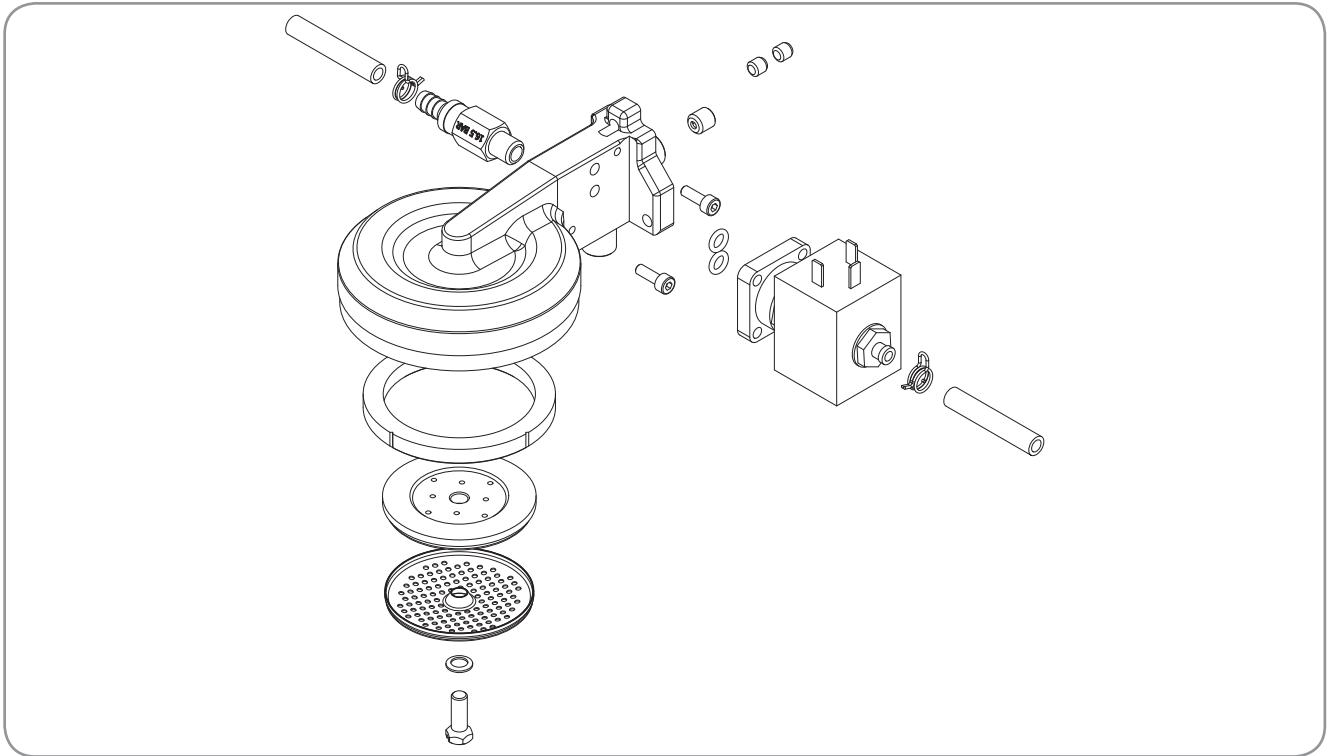
NOTE

To remove the front panel, you must remove the top panels and water from the drain pan.

- 1 Disconnect the connection to the panel.
- 2 Unscrew the screws "A" with a Phillips screwdriver.
- 3 Slight outside the steam nozzle, then slide the front panel to the front of the machine.



4. INFUSION UNIT



INDEX

4. INFUSION UNIT 4.1
 4.1 **REMOVAL OF SHOWER AND SEAL 4.2**
 4.2 **COFFEE VALVE 4.3**
 4.3 **EXPANSION VALVE 4.5**

TOOLS NEEDED:



The underpan seal prevents water from coming out from the sides of the pavilion and reach the capsule unevenly or spill from the filter holder. Since the material is plastic and exposed to high temperatures, replace the seal periodically, at least once a year or according to machine operation, as it tends to deform, loosening elasticity and sealing.

Fig. 35



4.1 REMOVAL OF SHOWER AND SEAL

To remove the shower and pavilion it is sufficient to loosen the central screw under the unit.

Fig. 36



WARNING

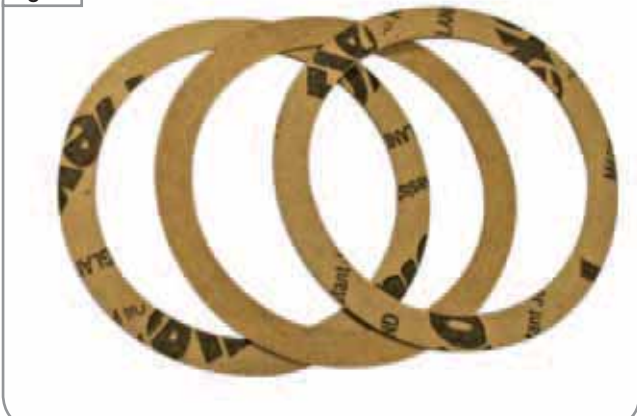
If the machine was turned off recently, protect yourself with thermal insulation gloves.

Fig. 37



To change the seal use an awl or a slim flathead screwdriver and at first remove one edge of the seal and then remove it entirely. If the unit is worn out just insert shims under the seal so as to reduce the stroke of the filter holder.

Fig. 38



4.2 COFFEE VALVE

It is a solenoid valve that is normally closed and opens when it received a command to dispense coffee.

By closing the decompression removes any excess water from the filter holder.

TYPICAL PROBLEMS

Check the operation of the valve, if the unit continues to drip continuously or if the coffee capsule is too wet.

Possible causes:

- 1 First check if the frame is too thin.
- 2 The third passage of the valve is obstructed, therefore the final suction is less than it should be.
- 3 Shower and pavilion are blocked because of poor machine cleaning.



DANGER

Before proceeding with the operations described in the chapter make sure that the machine is turned off and unplugged from the mains. Discharge any residual pressure present in the heater.

HOW TO REPLACE THE COFFEE VALVE:

To remove the coffee valve proceed as follows:

- 1 Remove the right, side panel and the front one, as explained in Chapter 3.
- 2 Disconnect power connections.
- 3 Disconnect the Teflon tube by removing the cable holder "A" using the pliers.

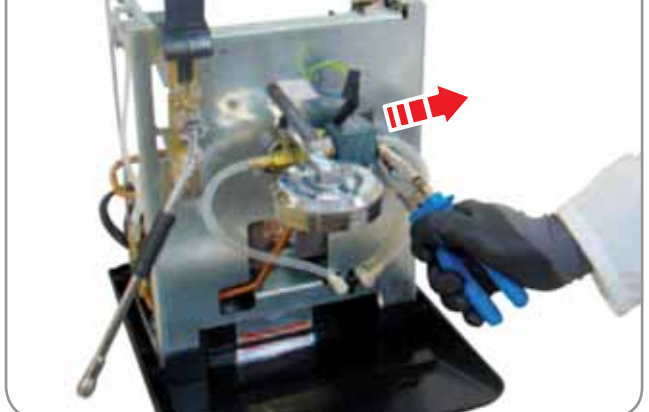
Fig. 39



Fig. 40

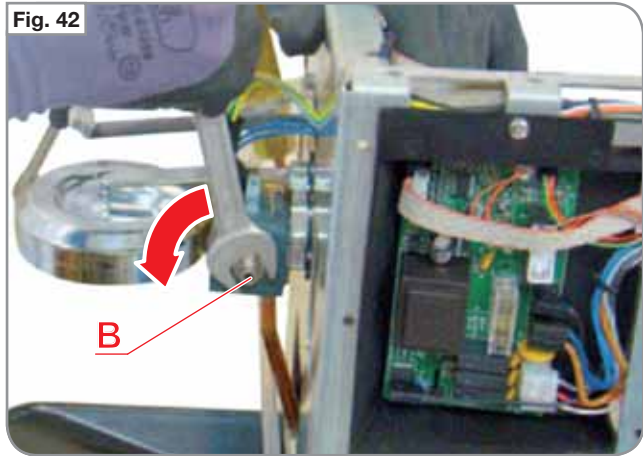


Fig. 41



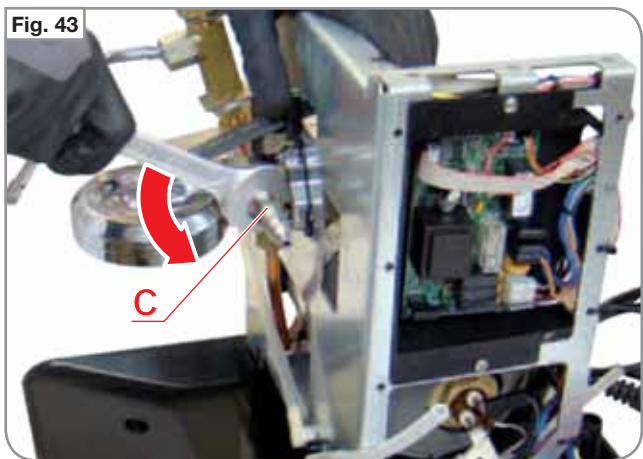
- 4 Remove the washer and the locking nut "B" using a 14 mm wrench. Remove the coil.

Fig. 42



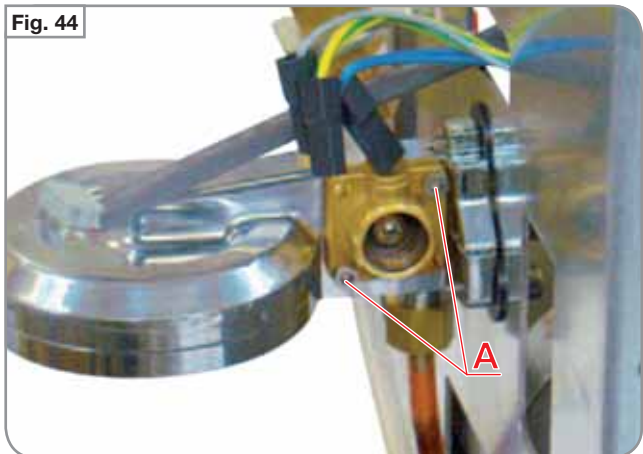
- 5 Loosen the coil support "C" with a 24 mm wrench.

Fig. 43



- 6 Use a 3 mm Allen key to remove the two screws that fix the head to the unit.

Fig. 44



Remove lime scale or oily residues that may block the free circulation of water.

Fig. 45



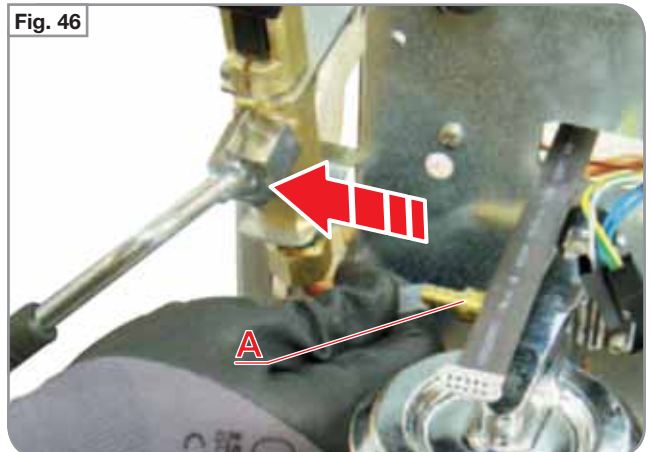
NOTE

In case of oily residues, properly instruct the staff using the machine to perform a regular, deep cleaning with suitable detergents.

4.3 EXPANSION VALVE

To remove the expansion valve, proceed as follows:

- 1 Remove the front panel.
- 2 Disconnect the Teflon tube by removing the cable holder "A" using the pliers.



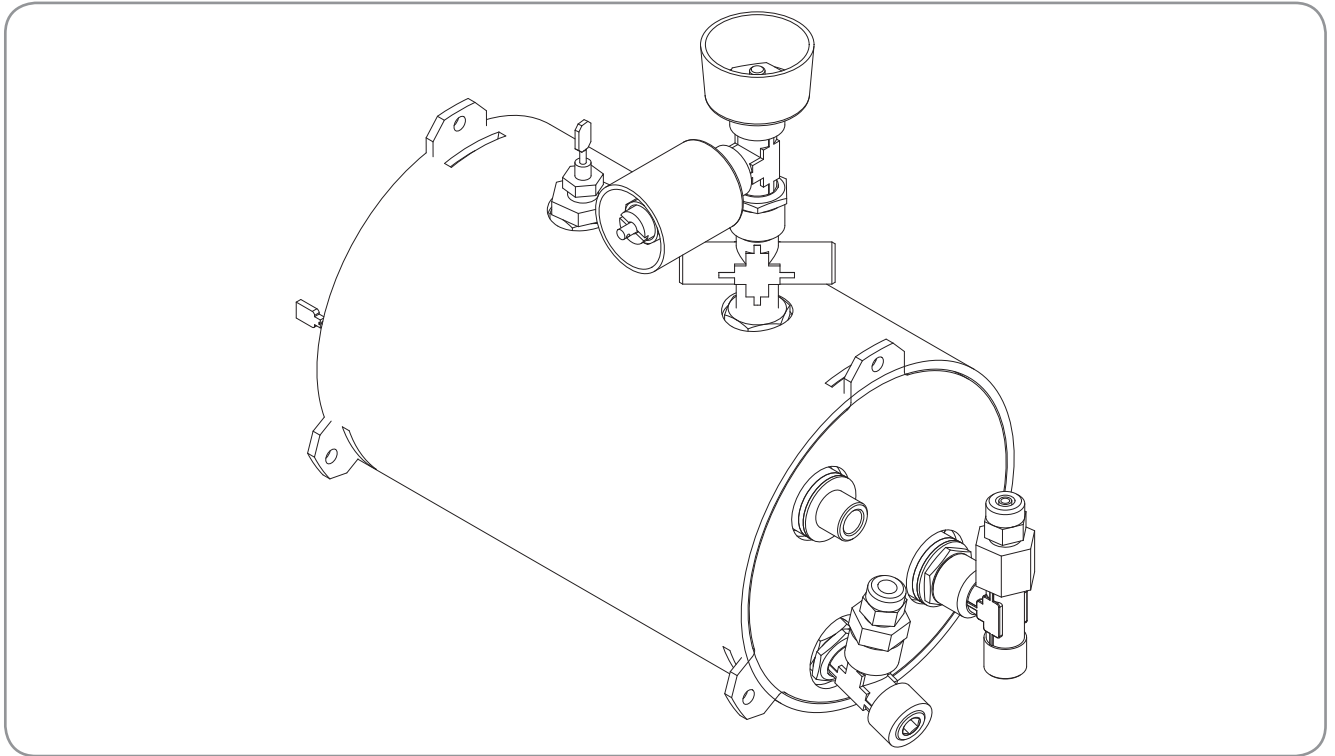
- 3 Loosen the valve with a 14 mm wrench.



- 4 Apply Teflon tape on the new valve before screwing it.



5. HEATER



INDEX

5. HEATER 5.1

5.1 EMPTYING THE HEATER 5.2

5.2 REMOVAL OF THE HEATER 5.4

5.3 HEATING ELEMENT AND HEAT PROTECTION 5.5

5.4 REPLACEMENT OF THE LEVEL GAUGE 5.6

5.5 ANTIVACUUM VALVE 5.7

5.6 SAFETY VALVE 5.8

TOOLS NEEDED:



5.1 EMPTYING THE HEATER



DANGER

Before proceeding with the operations described in the chapter make sure that the machine is turned off and unplugged from the mains. Discharge any residual pressure present in the steam heater.



WARNING

Before carrying out the heater emptying procedure, remove water inlet sources inside the waterline:

- **Waterline version:** close the water inlet tap and disconnect the pipe.
- **Tank version:** remove the tank from its seat.

These operations are necessary to avoid any water leakage inside the machine that may cause damage.



WARNING

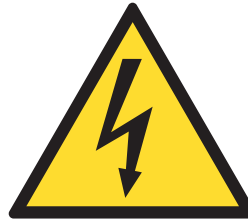
Every time you work directly.

With the heater it is important to ensure that the internal pressure is zero. Completely remove the water inside for operations that require it.

To empty the heater proceed as follows:

- 1 Turn off the machine and let out all the steam by opening fully the steam outlets to lower the temperature quickly.
- 2 Remove covers:
 - Side panels;
 - Rear panel;
 - Front panel.
- 3 Place the machine on the right side to prevent water leakage and loosen the drain nut "A" using a 13 mm wrench.

Fig. 49



DANGER

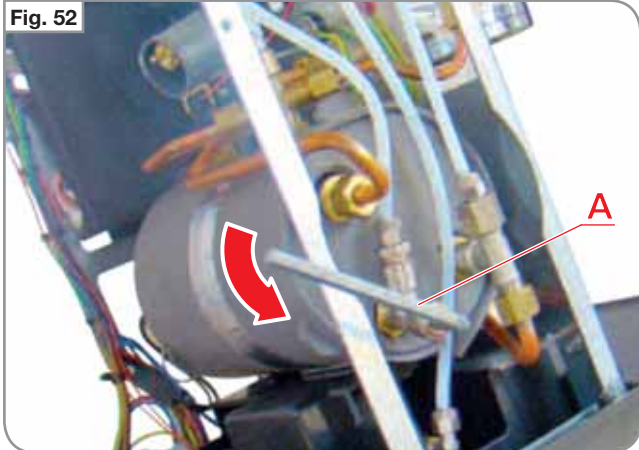
Fig. 50



Fig. 51



Fig. 52



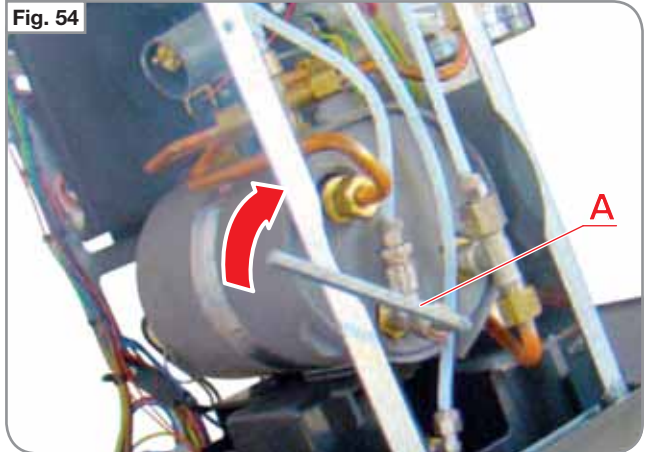
- 4 Connect the drain pipe and tilt the machine on the left side to let the water out of the heater.

Fig. 53



- 5 After drainage of water from the heater, tighten the drain nut "A" using a 13 mm wrench.

Fig. 54



5.2 REMOVAL OF THE HEATER

In case of need, to remove the heater, it is necessary to discharge pressure.

Then, proceed as follows:

- 1 Remove machine covers:
 - Rear panel;
 - Side panels;
 - Front panel.

- 2 Empty water heater, as in the previous section.

- 3 Disconnect the level probe.

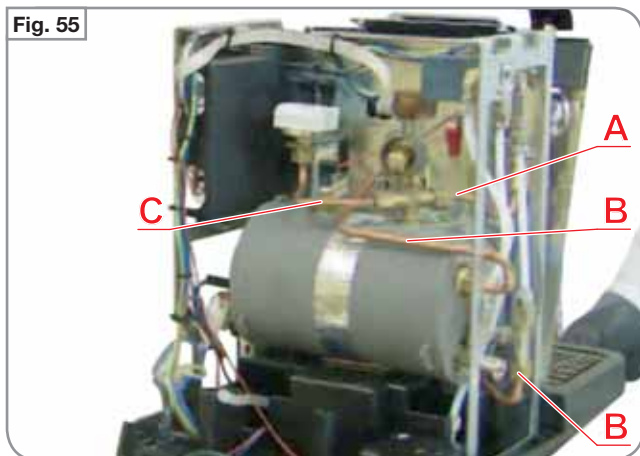
- 4 Disconnect the pressure gauge capillary.

- 5 Remove the fittings on the upper part of the heater with a 17 mm wrench:
 - A** Steam Nozzle;
 - B** Coffee delivery group;
 - C** Hot Water Nozzle.

- 6 Remove the remaining fittings that hold the heater in place.

- 7 Remove the fittings on the left side:
 - A** using a 12 mm wrench.

The heater can be extracted from the machine. During the assembly phase of the new boiler, pay close attention to the restoration of the connections to ensure proper operation.



5.3 HEATING ELEMENT AND HEAT PROTECTION

To access the heating element, remove the right panel of the cover.

The visible parts are:

- A** 167° heat protection.
- B** Electrical connections of heating element.

OSCAR II heater features a 1200 W heating element.

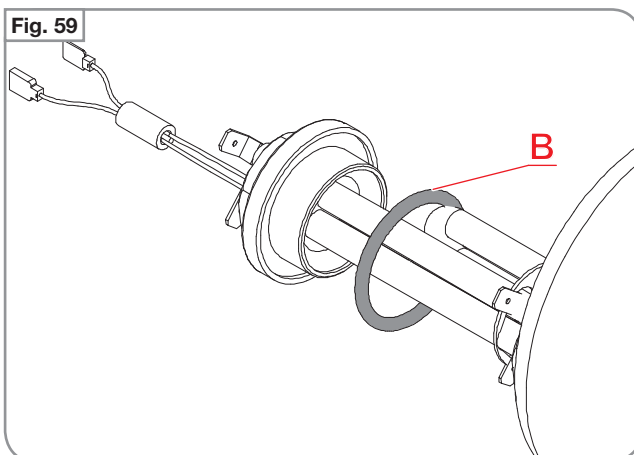
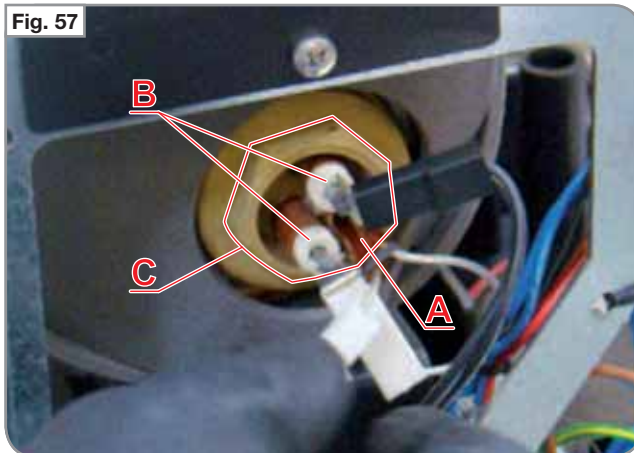
To remove the heating element, proceed as follows:

- 1 Empty the heater as described above.
- 2 Loose the nut "A" using a 30 mm wrench.

- 3 Remove with care the panel out of its slot.

NOTE

Each time you replace the heating element, it is also necessary to change the O-ring "B", which insulates it from the heater, as it is a part subject to wear. This component must be ordered along with the heating element.



5.4 REPLACEMENT OF THE LEVEL GAUGE

Water inside the heater is kept at a constant level through the use of a level probe.

This probe is connected to the electronic unit, which continuously checks water level.

Being always exposed to high temperatures and steam/water it is subject to encrustations which can inhibit operations.

WHEN TO INTERVENE

- In case it is verified that there are no problems upstream from the probe you can easily access the component and perform careful cleaning with abrasive or descaling agents.
- Make sure the Teflon coating of the probe is not damaged. In case of damage, steam leaks occur and it is necessary to replace the probe.

To remove the probe, simply disconnect the red wire "A" and unscrew the locking bolt "B" with a 16 mm wrench.



NOTE

When replacing the probe it is necessary to cover the threads with Teflon tape or liquid sealant.

Fig. 60



Fig. 61

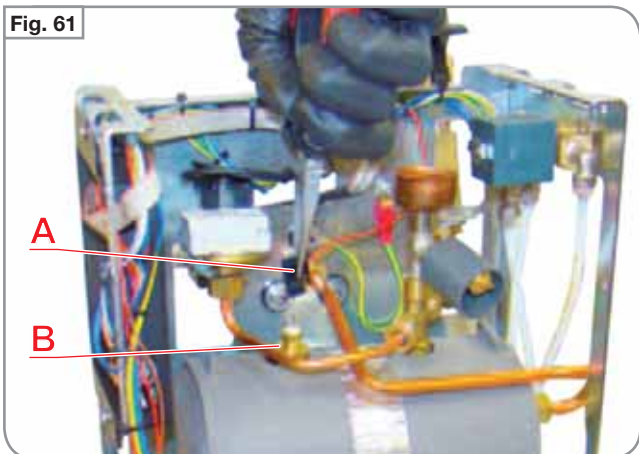


Fig. 62



5.5 ANTIVACUUM VALVE

The antivacuum valve ensures that air enters the heater during the machine cooling phase. In this way the reduction of water volume due to cooling does not create decompressions that may give rise to drawbacks such as the suction of milk through the steam nozzle.

WHEN TO REPLACE

You can assume that there are problems with the antivacuum valve when water coming out from heater is dirty.

The bad smell is generated from milk that has been sucked into the heater. In these cases the valve is closed and is locked in this condition.

If the valve blocked open because of limescale the signs would be:

- A** Continuous slight whistling sound coming from the valve.
- B** Condensation drops near the valve.



NOTE

We suggest that the valve be replaced annually to ensure proper function and excellent sealing.

HOW TO REPLACE

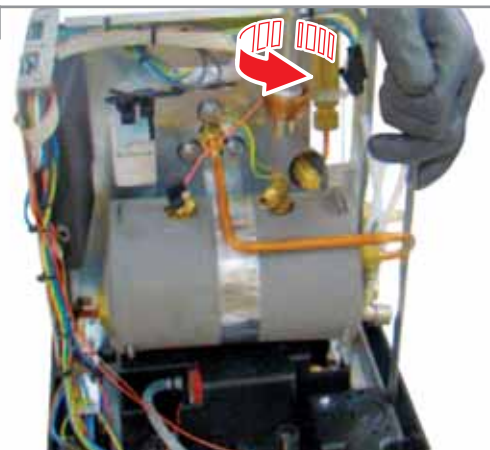
Using a 19 mm cup hex wrench unscrew the valve from its housing.

When inserting the new one, coat the threads with Teflon tape or with a few drops of Loctite.

Fig. 63



Fig. 64



5.6 SAFETY VALVE

The heater safety valve “A” of heater serves to discharge excess pressure that may form owing to malfunctioning. The valve opens automatically when inner pressure of heater exceeds 2.1 bar.

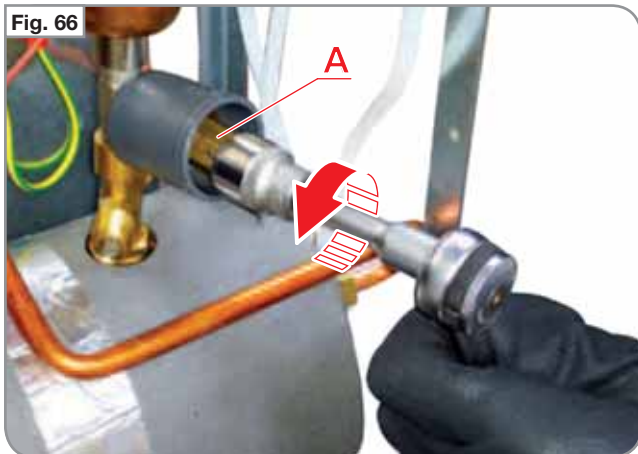
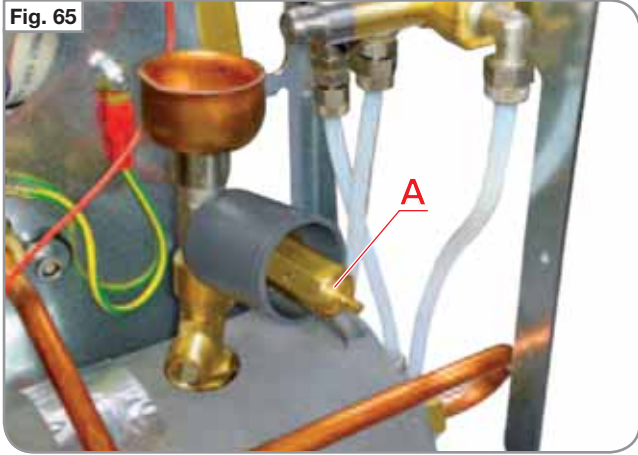
WHEN TO REPLACE

For safety reasons each time the valve comes into operation it should be replaced to ensure perfect operation.

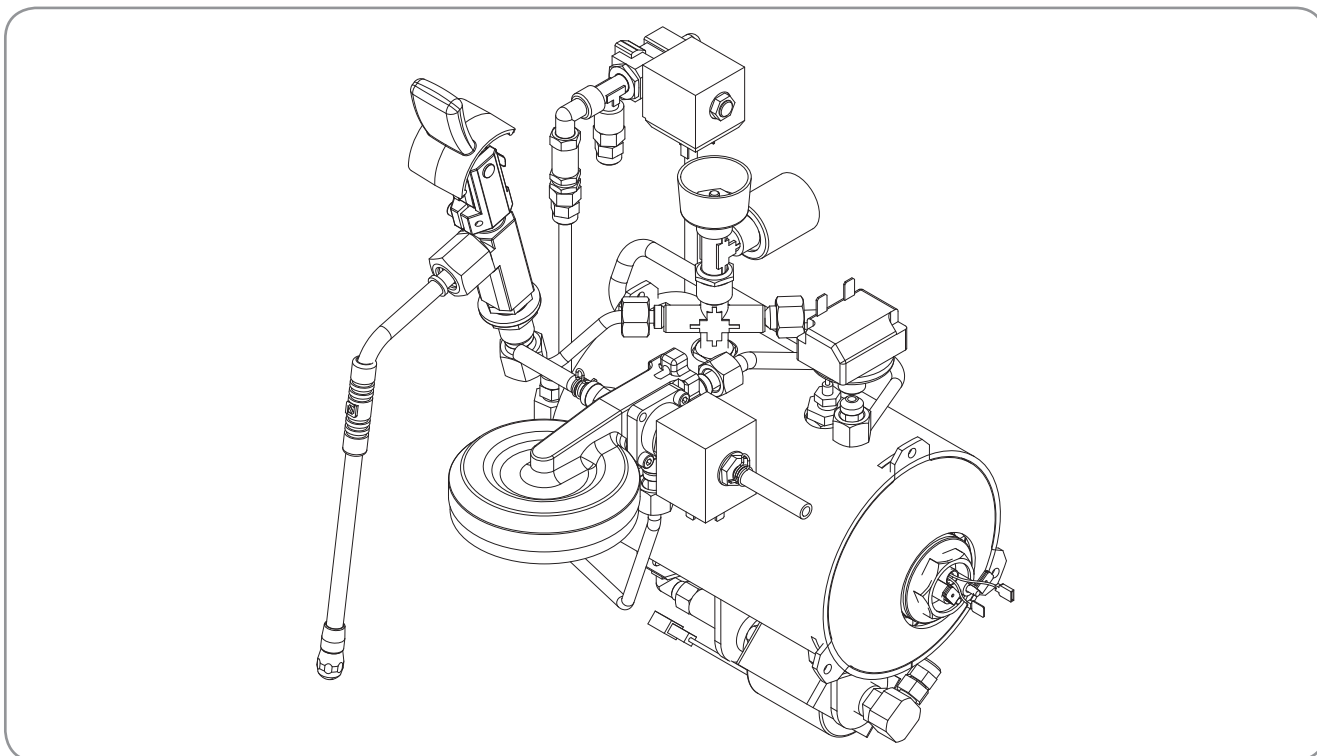
Therefore, in case of heater flooding or excess of steam, secure the machine by replacing the entire valve.

HOW TO REPLACE

Remove the safety valve “A” by unscrewing it with a 14 mm hex wrench.



6. HYDRAULIC CIRCUIT



INDEX

6. HYDRAULIC CIRCUIT 6.1

6.1 PUMP DISASSEMBLY 6.2

6.2 REPLACING THE COFFEE VALVE . . . 6.4

6.3 STEAM NOZZLE 6.6

6.4 WATER TANK 6.11

6.4.1 REPLACEMENT OF THE FLOAT 6.11

6.4.2 REMOVAL OF THE MAGNETIC SENSOR 6.12

6.5 REMOVAL OF THE PRESSURE SWITCH 6.12

TOOLS NEEDED:





WARNING

Before carrying out the disassembly procedure of the hydraulic circuit, close water inlet sources inside the waterline:

- **Waterline version:** close the water inlet tap and disconnect the pipe.
- **Tank version:** remove the tank from its seat.

These operations are necessary to avoid any water leakage inside the machine that may cause damage.

6.1 PUMP DISASSEMBLY

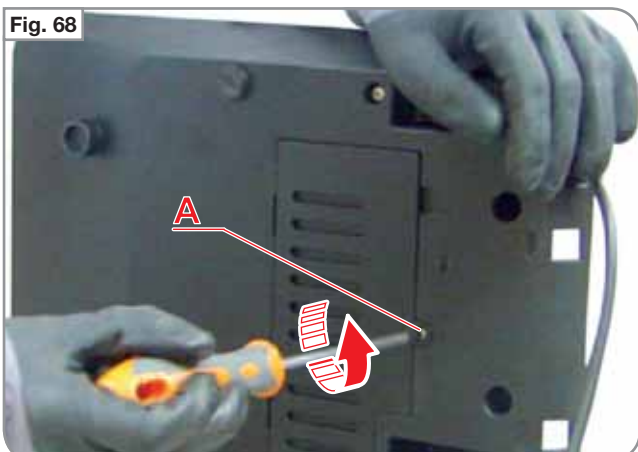
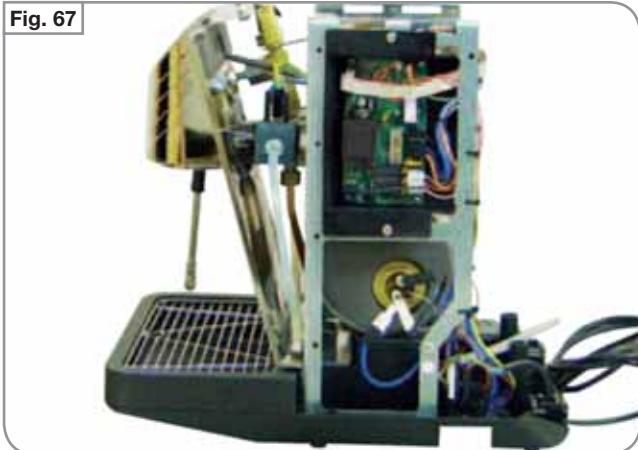
The pump is situated on machine bottom. The duration depends on the amount of daily work and the quality of water.

WHEN TO REPLACE THE PUMP

- 1 During delivery, no water comes out of the unit.
- 2 In case the machine remains inactive for too long, the pump does not deliver owing to oxidation of fittings.
- 3 Continuous overheating even in the presence of water.

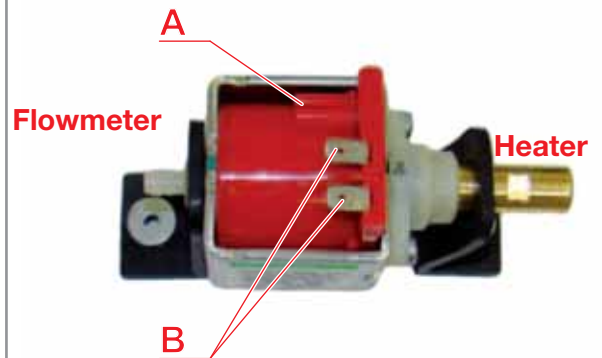
If the pump needs to be removed, it is necessary to:

- 1 Remove the side and rear panels.
- 2 Release the pump from its seat by loosening the screws "A" of the bottom panel with a Phillips screwdriver.



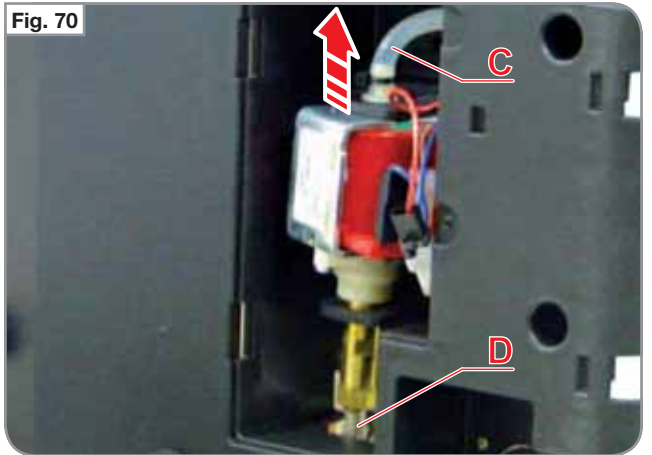
- 3 Disconnect the electrical connections of the pump using the tweezers:
- A: temperature probe.
 - B: power supply.

Fig. 69



- 4 Disconnect the hydraulic connections of the pump:
- From the flowmeter, disconnect the Teflon pipe "C".
 - From the pump to the heater, unscrew the fitting "D" using a 13 mm spanner.

Fig. 70



- 5 Take the pump out of the machine.

**NOTE**

Check the water inlet filter situated in the heater connection and replace it, if necessary.

**NOTE**

When replacing the pump, replace the O-ring code No. 02280007.V, too (see tables at the end of the manual).

6.2 REPLACING THE COFFEE VALVE

The coffee valve "A" is situated underneath the upper panel, on the left side, and regulates the amount of water flowing inside the heater during all phases of machine operation.

WHEN TO INTERVENE

- 1 The system detects the absence of water and the pump is set off but the pump sounds like it's straining badly: the valve is stuck.
- 2 There is a general short circuit: the coil may be short-circuited due to micro leaks or electrical shock.
- 3 The heater flooded: the impurities have prevented the valve from closing properly.

HOW TO REPLACE THE COFFEE VALVE

To remove the coffee valve, it is necessary to:

- 1 Disconnect power connections using tweezers "B".
- 2 Using a 14 mm wrench, remove the bolt "C" that holds the coil in place and ease it out of its housing. Under optimal conditions, the removal is immediate but if parts are blocked, force removal as much as possible.

Fig. 71

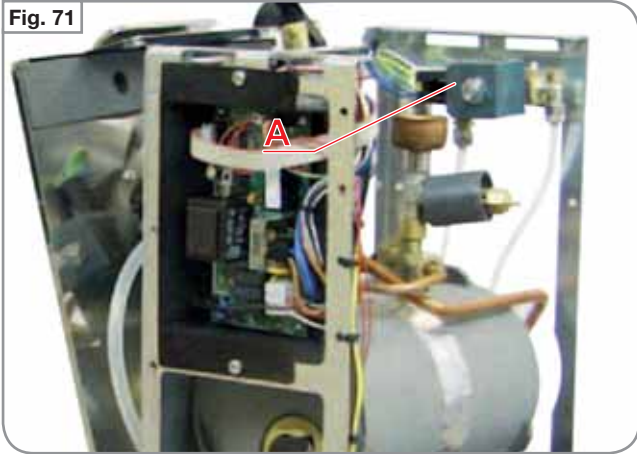
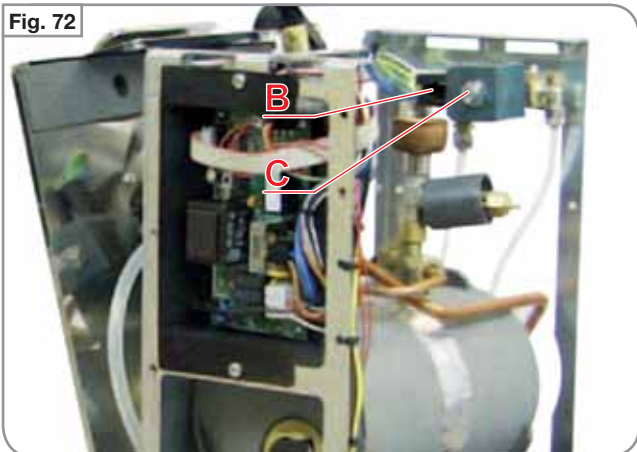
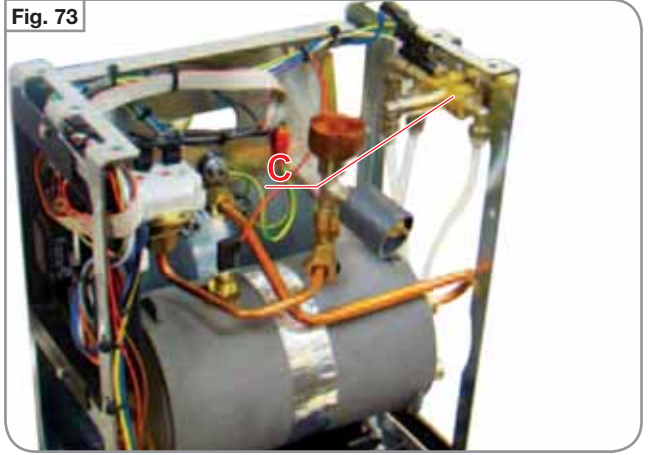


Fig. 72



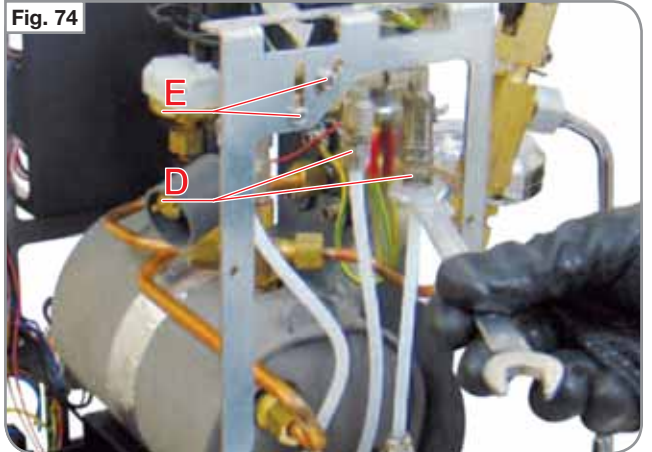
- Using a 24 mm wrench, remove the fixed part "C".

Fig. 73



- Disconnect the hydraulic connections "D" by using a 12 mm wrench.
- Loose the locking screws "E" to release the valve from the machine frame.

Fig. 74



- Make sure the plunger is clean and there are no obstructions. Replace the valve if it is not working.

Fig. 75



6.3 STEAM NOZZLE

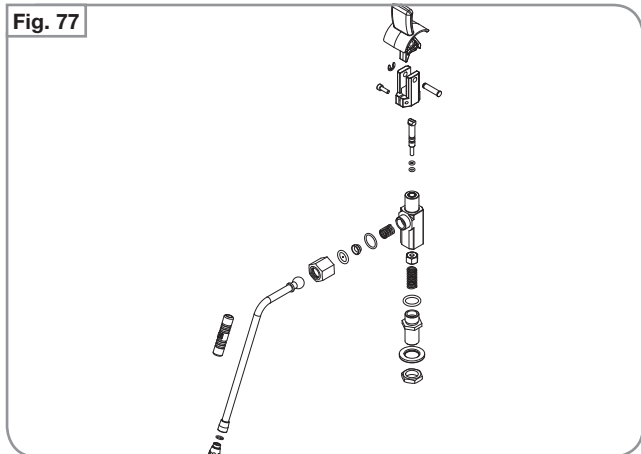
The steam nozzle is composed of a piston actuated by the knob, which presses on a nut with spring return. By pressing against the spring it creates space for the steam to pass.

We suggest to replace the seals that keep the piston perfectly aligned, every 4-6 months. Every year it is advisable to replace the nut to prevent the gasket that insulates the steam from drying and letting steam pass. Since these parts must be changed, we suggest replacing all the seals simultaneously.

WHEN TO INTERVENE

Problems related to the steam nozzle are:

- Continuous loss of steam.
- Water dripping from the steam nozzle.
- Delayed closure.
- Steam lever too loose.



 **DANGER**

Before proceeding with the operations described in the chapter make sure that the machine is turned off and unplugged from the mains. Discharge any residual pressure present in the steam heater.

If there is a loss of steam or condensation, it is necessary to:

- 1 Turn the machine off, let out all the steam until there is no pressure in the heater.
- 2 Remove the left side panel and the front one.

- 3 Loose the steam nozzle by means of the nut "A" using a 22 mm wrench, by levering the nozzle locking nut with a 23 mm wrench, as shown on the figure.

- 4 Loose the steam pipe fitting of the nozzle by means of a 20 mm wrench, by levering the locking nut with a 23 mm wrench, as shown on the figure.
- 5 Unscrew the locking nut of the steam nozzle with a 23 mm wrench, by levering the steam valve block with a 22 mm wrench.

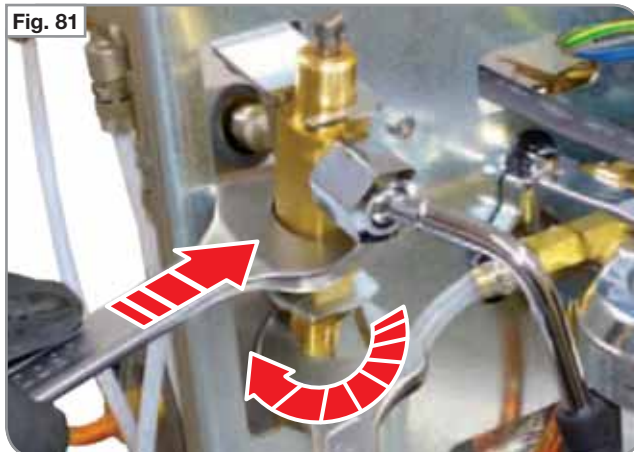
Fig. 79



Fig. 80



Fig. 81



DISASSEMBLY OF THE STEAM LEVER

1 Remove screw "A" with an Allen key 3 mm.

2 Remove the clip "B" using pliers.

3 Pull the lever pin "C" to release the steam lever "D".

4 To remove the dispensing nozzle it is sufficient to unscrew the lower part of the nozzle by hand. We recommend annual replacement O-ring seals.

Fig. 82

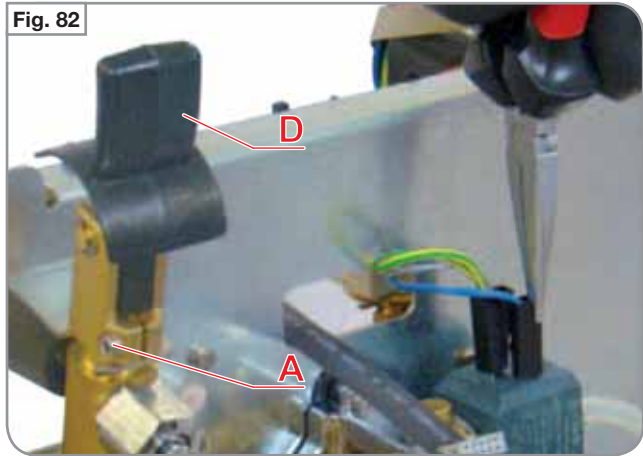


Fig. 83

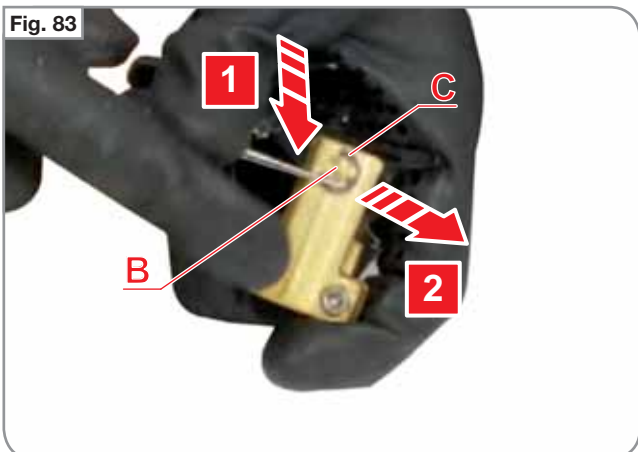


Fig. 84



Fig. 85



MAINTENANCE OF STEAM NOZZLE

To carry out repairs and maintenance once the steam nozzle is removed we can proceed with the following steps:

1 Remove the piston which is actuated by the lever. The seals that make it slide in its housing tend to wear out and must be replaced depending on the use or every 4-6 months.

- 2 Using a 22 mm wrench remove the steam nozzle from its housing. We recommend replacing the seal at least once a year.

- 3 Unscrew the fitting "A" with a 21 mm wrench to reach the spring.
We recommend replacing the seal at least once a year.
- 4 Remove the steam piston "C" behind the spring "B".
We recommend replacing the piston at least once a year.

The steam nozzle, in its simplicity, has components that must be replaced due to wear. It is recommended to replace:

- The piston seals (code No. 02280014) to avoid misalignment.
- The seals of the lever block (02280011) and the connection to the heater.
- The piston of inner closure (98008004).

RE-ASSEMBLY OF THE STEAM NOZZLE

During the reassembly phase it is important to lubricate the seals of the piston in contact with the lever, to ensure fluid movement inside the housing.

Fig. 86

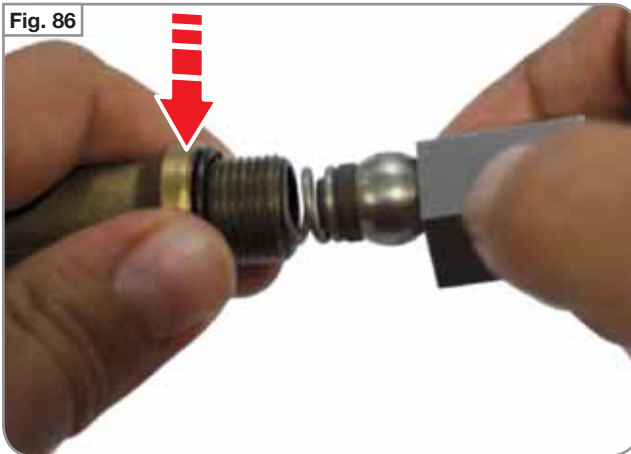


Fig. 87

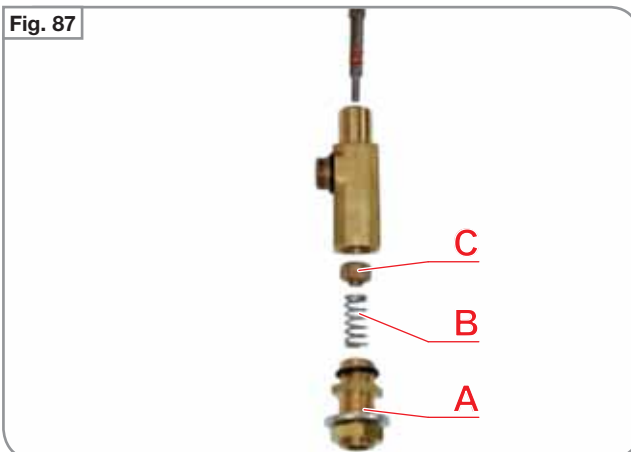


Fig. 88

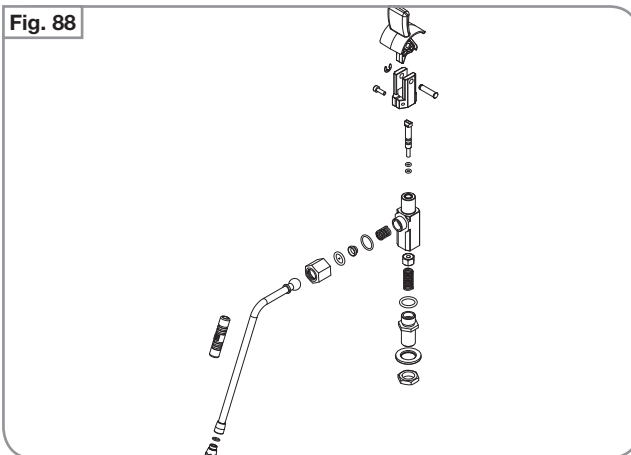


Fig. 89



**WARNING**

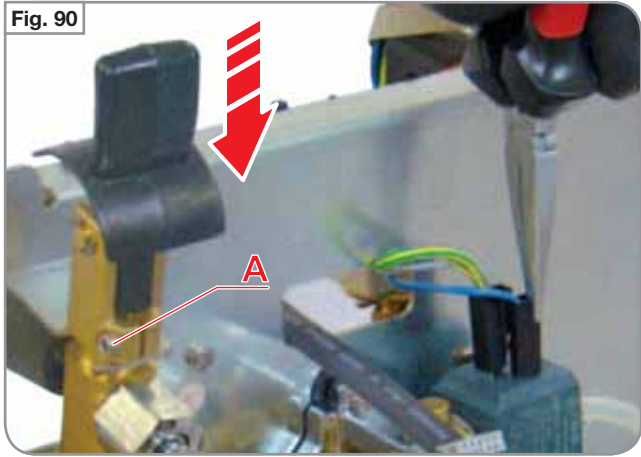
Operation to be performed when the machine is on.

When fixing the screw that holds the lever on the steam nozzle it is necessary to:

- 1 Lightly press the lever upwards to let steam come out.
- 2 Release the lever until the steam supply stops.
- 3 Tighten the lever locking screw on the steam nozzle.

In this way, there is a precise calibration of the steam nozzle.

Fig. 90



6.4 WATER TANK

To access the water tank, remove the rear panel.



NOTE

In case of a prolonged inactivity of the machine, the tank valve may be blocked owing to limescale.

To release the tank valve, use a screwdriver to allow water discharge.

Check the valve for the presence of limescale and the conditions of seal "A". Replace the faulty parts, if necessary.

6.4.1 REPLACEMENT OF THE FLOAT

- 1 Take out the water tank and remove the rear panel.
- 2 Manually remove the tank float.



NOTE

During the assembly phase of the new float, make sure the "+" mark on the float itself is oriented towards the tank bottom.

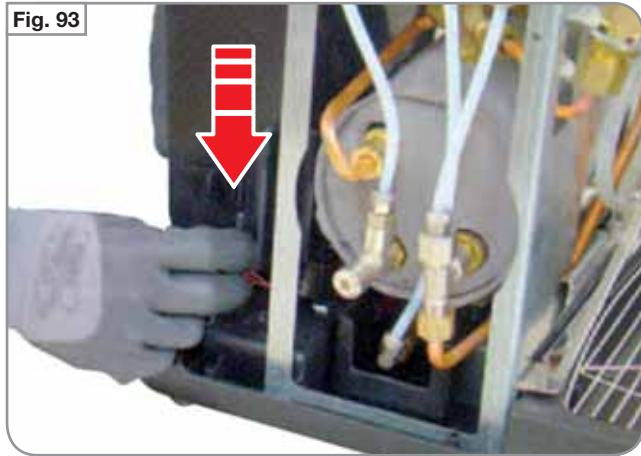


6.4.2 REMOVAL OF THE MAGNETIC SENSOR

This sensor serves to detect the presence of water inside the tank. In case of breakdown or malfunctioning, it can be replaced.

- 1 Remove the side and rear panels.
- 2 Move the sensor down, pay attention to the electrical connections.
- 3 Disconnect the sensor unit and replace.

Fig. 93



6.5 REMOVAL OF THE PRESSURE SWITCH

The pressure switch cuts off the circuit powering the heating element. Therefore, it will read a voltage as the one of mains when heater pressure is enough, while will read 0V when the heating element is warming up.

It is advisable to replace the pressure (pressure) every two years in order to avoid failure.

You need to replace when:

- 1 Car does not heat (light resistance still is, but the machine is cold and the heater works). The pressure is locked in the OFF state.
- 2 The production of the steam engine of water from the inside, because of the overheating and the open safety valve. Pressure switch is locked in the ON state.

To remove the pressure switch "A", it is necessary to:

- 1 Remove the right, side panel.
- 2 Disconnect the electrical connections.
- 3 Unscrew the fitting "B" with a 17 mm wrench.

Fig. 94



Fig. 95

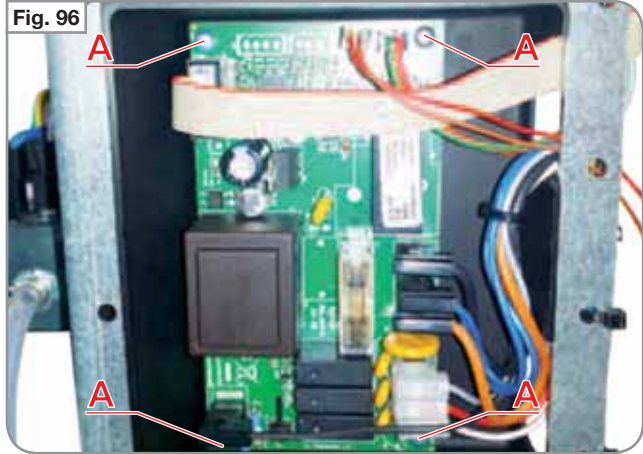


7.1 CONTROL UNIT

To access the main board it is necessary to:

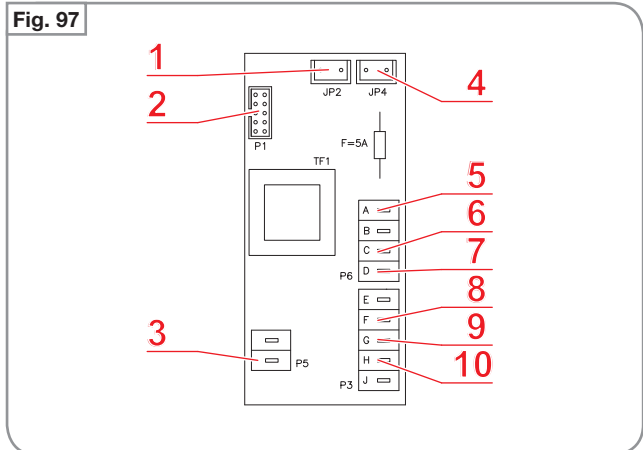
- 1 Remove the right side panel.
- 2 Disconnect the electrical connections using the pliers.

- 3 Loosen the board locking screws "A" on the support using a Phillips screwdriver.

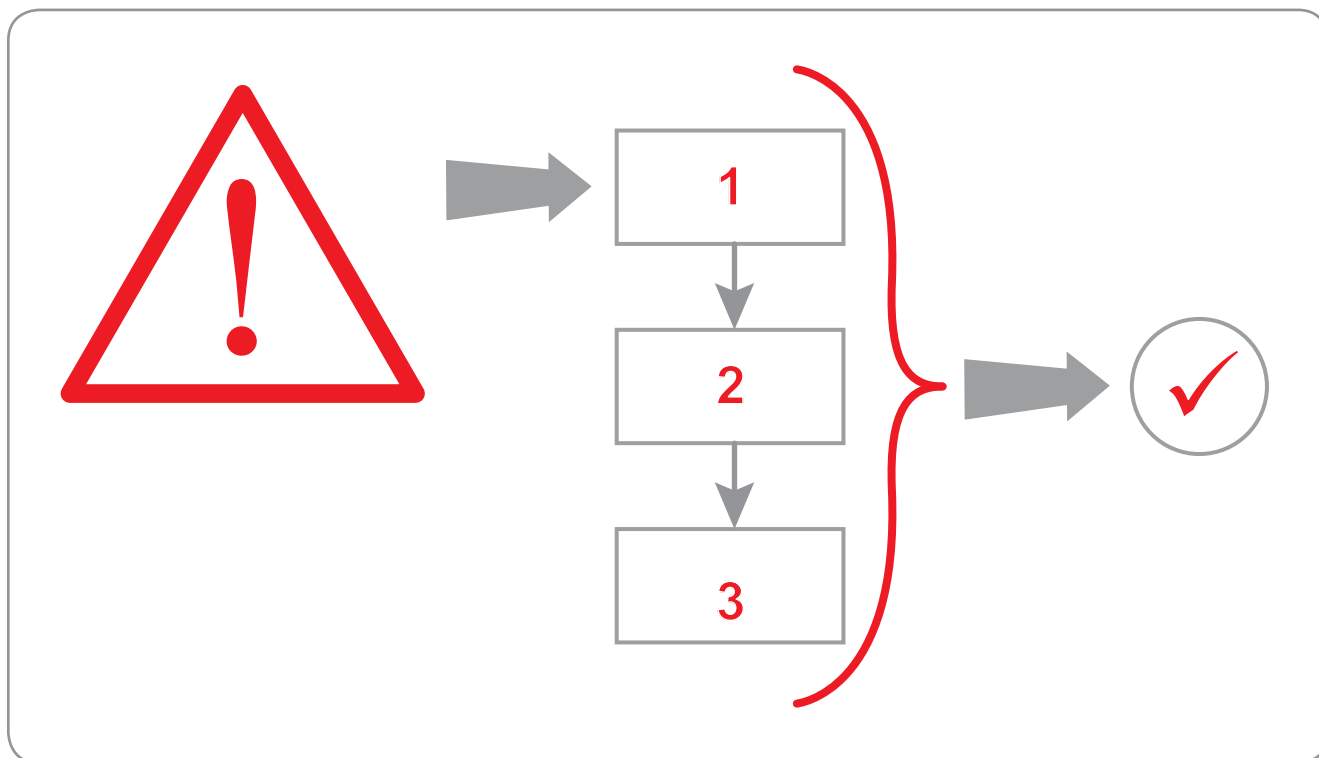


The control unit without connections appears as shown in the figure.

- 1 Tank level
- 2 Keyboard
- 3 Heating element
- 4 The boiler
- 5 Heating element
- 6 Neutral
- 7 Phase
- 8 Valve group
- 9 Pump
- 10 Water level



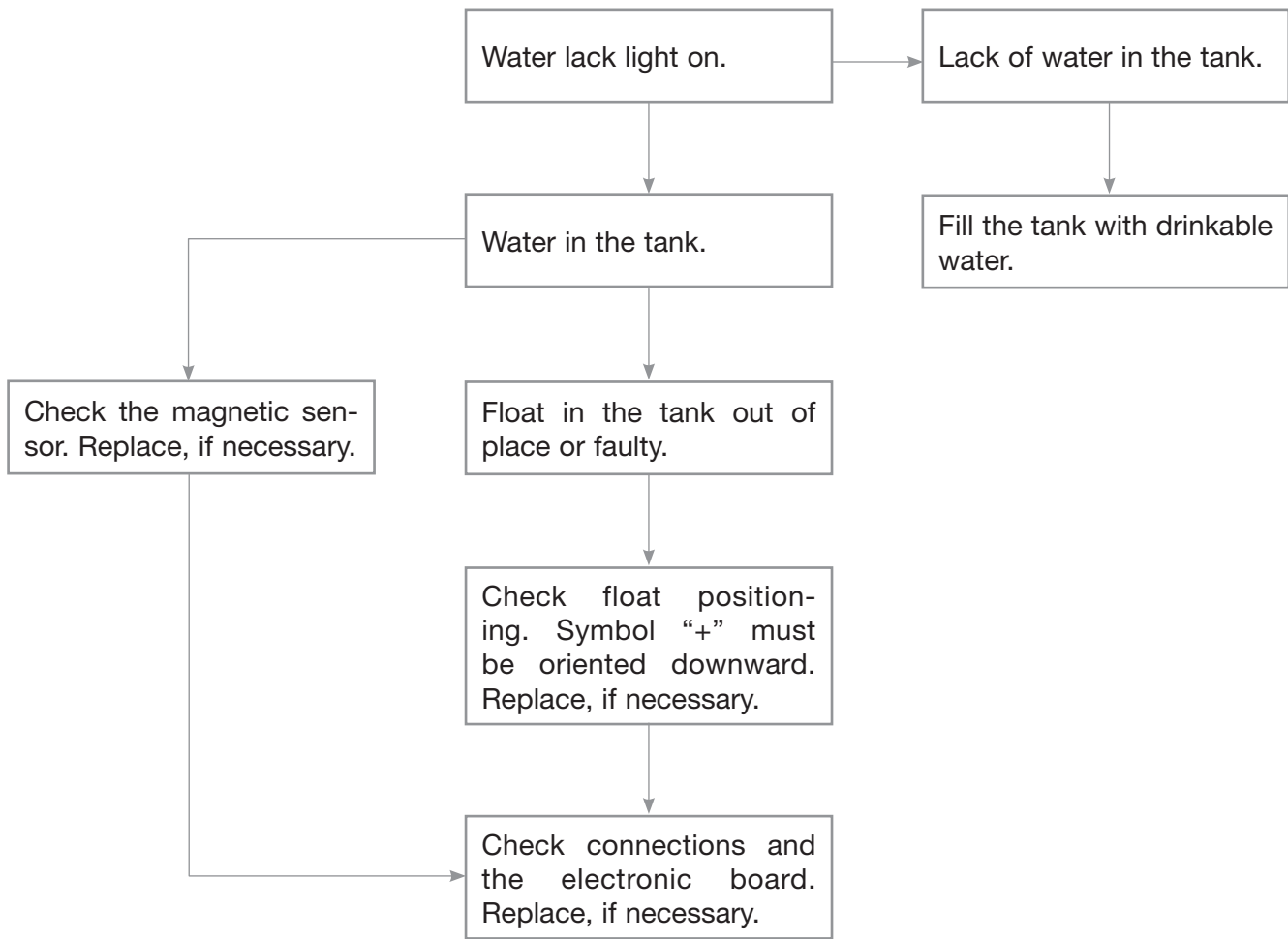
8. TROUBLESHOOTING



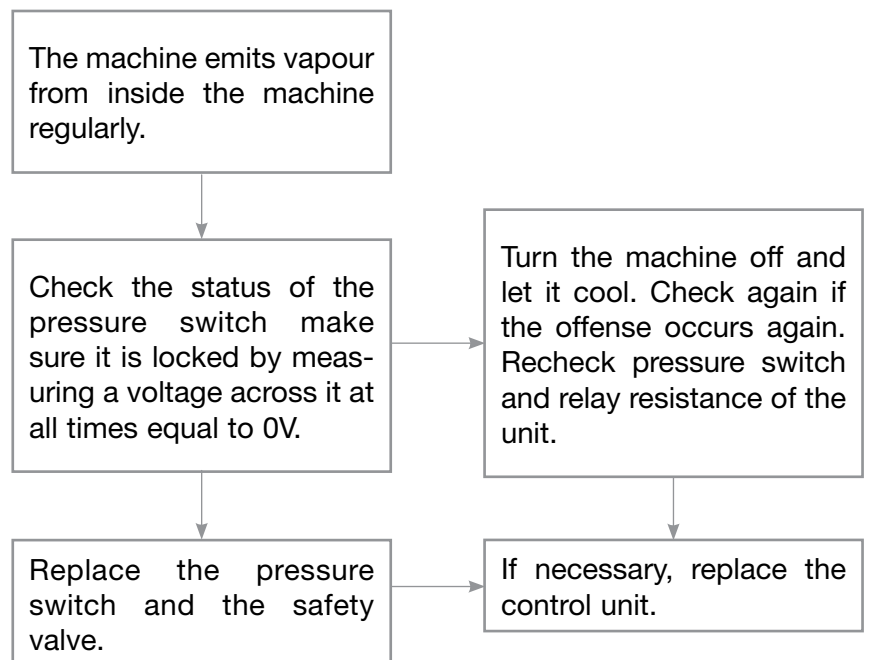
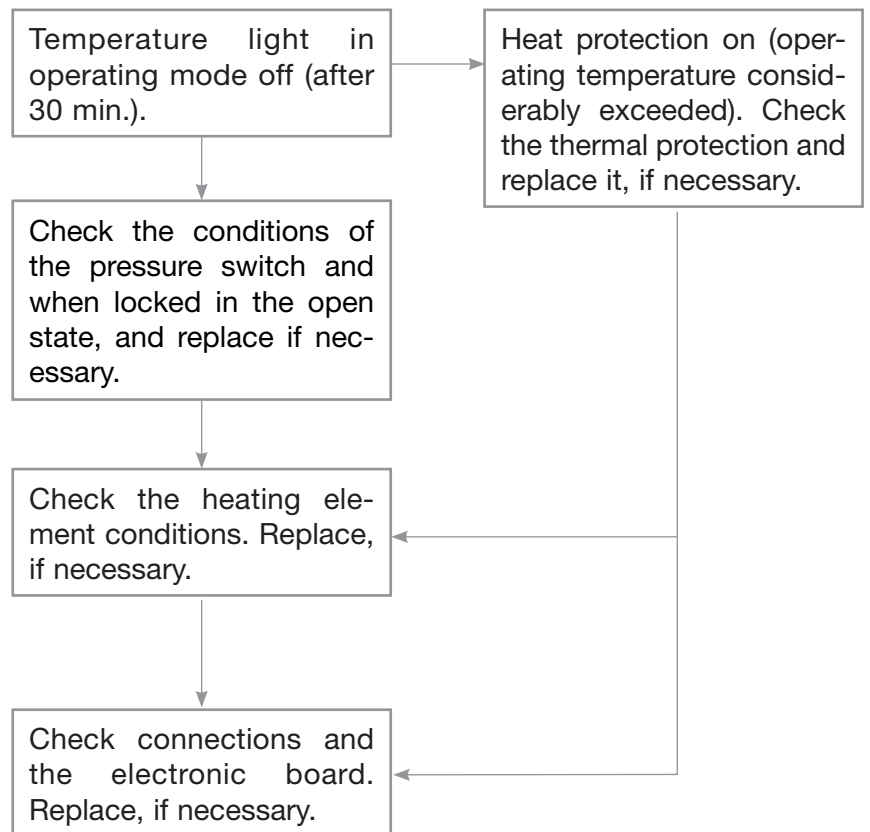
INDEX

8. TROUBLESHOOTING.....	8.1
8.1 WATER LACK LIGHT.....	8.2
8.2 HEATING ELEMENT LIGHT.....	8.3
8.4 COFFEE DELIVERY.....	8.4
8.5 STEAM DELIVERY.....	8.4
8.6 HEATER.....	8.5

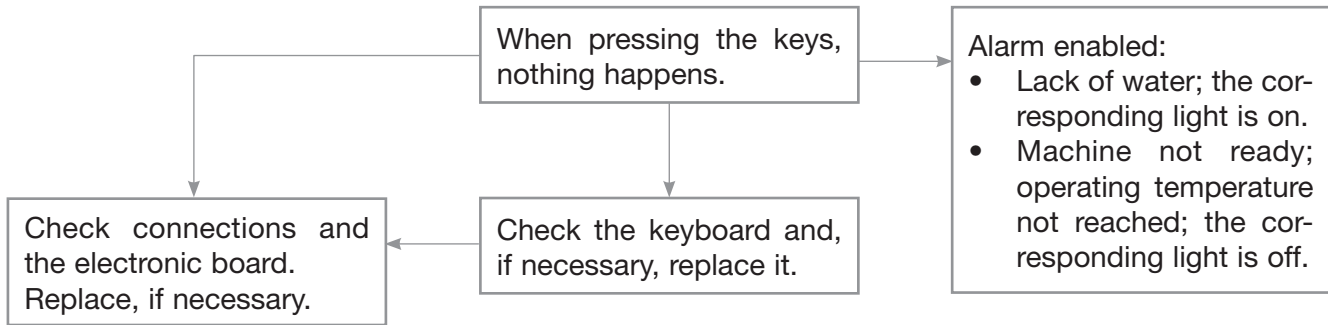
8.1 WATER LACK LIGHT



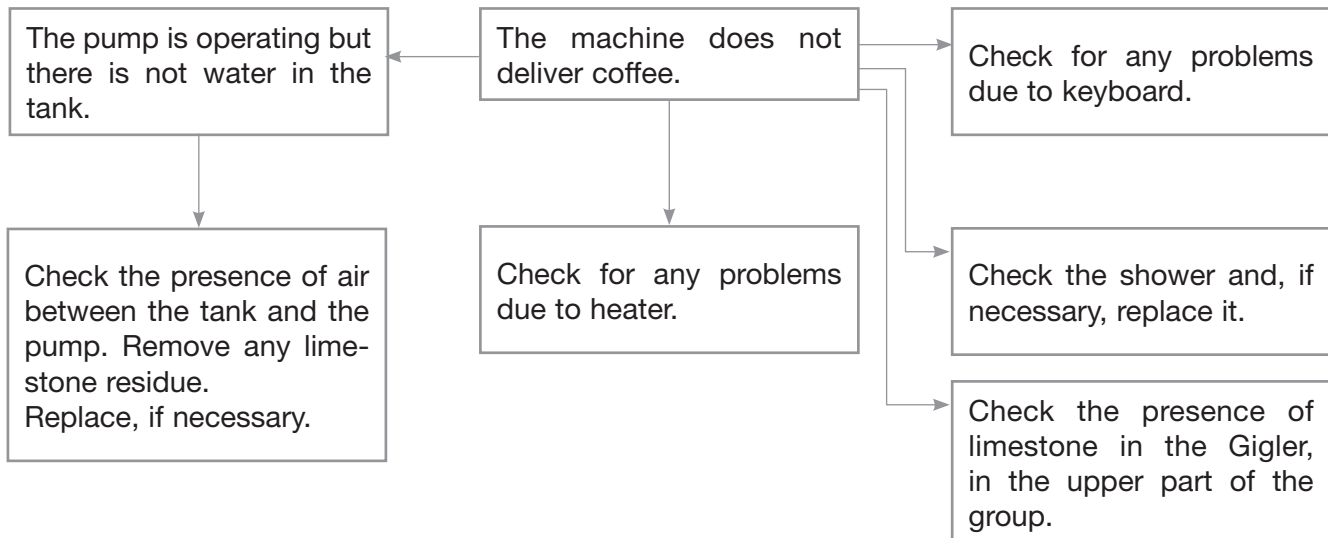
8.2 HEATING ELEMENT LIGHT



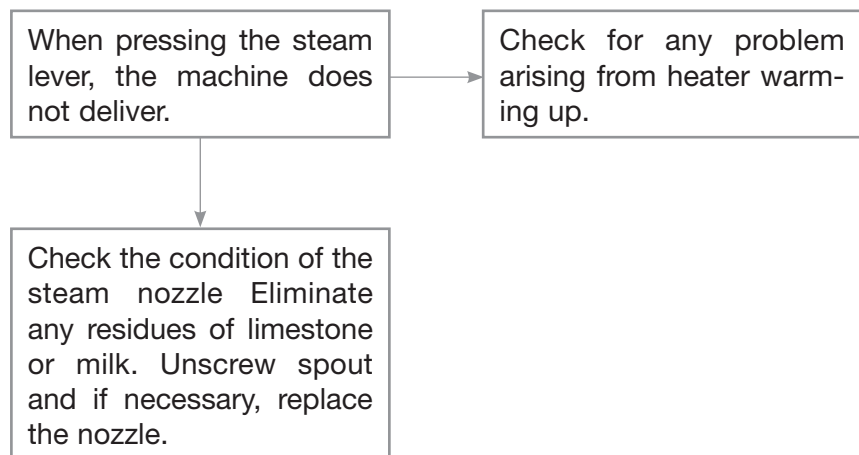
8.3 REMOVAL OF KEYBOARD



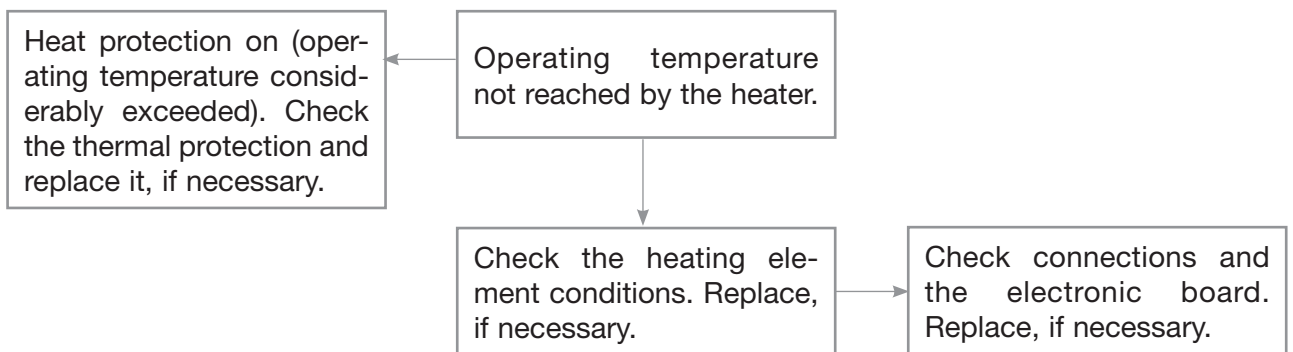
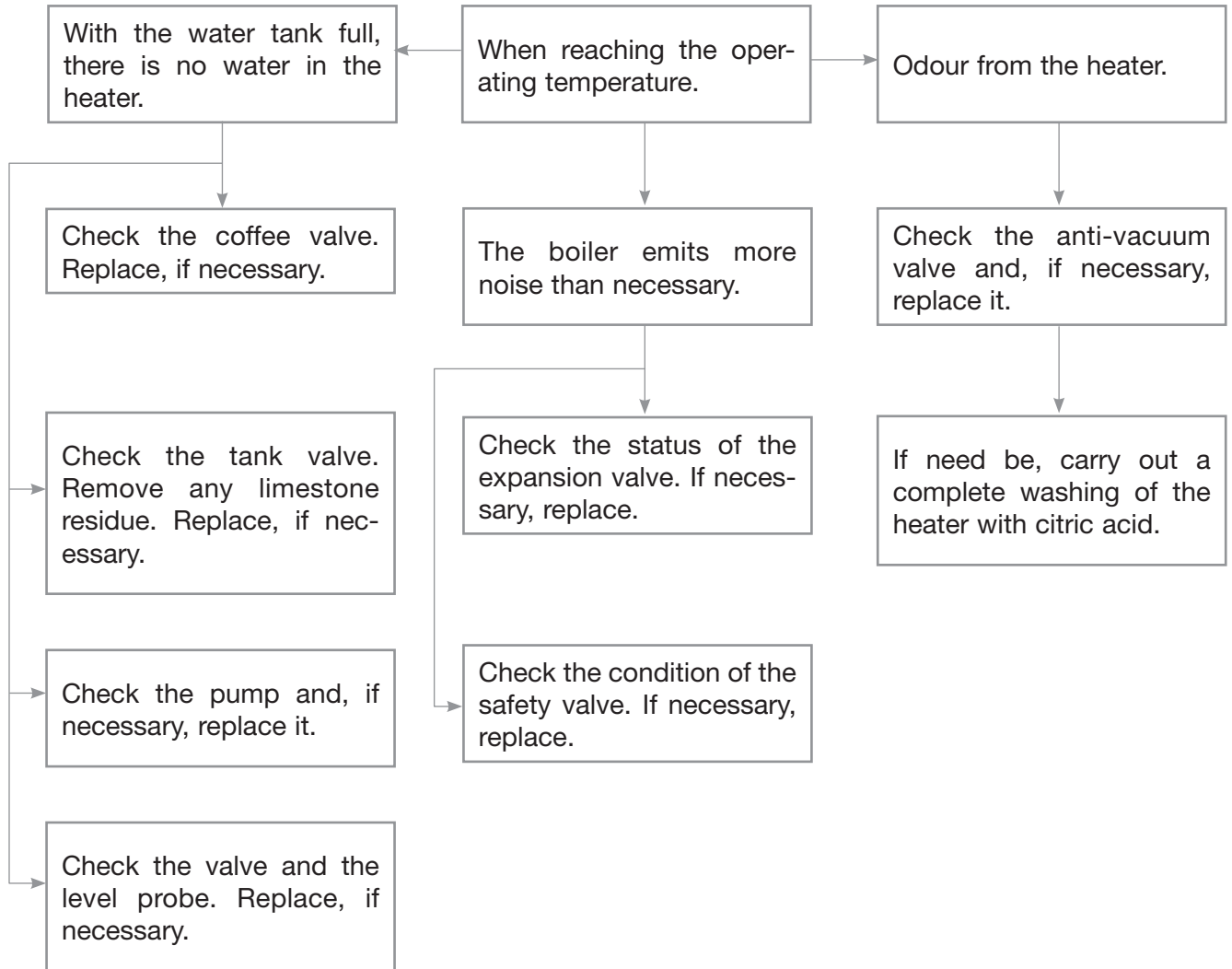
8.4 COFFEE DELIVERY



8.5 STEAM DELIVERY



8.6 HEATER



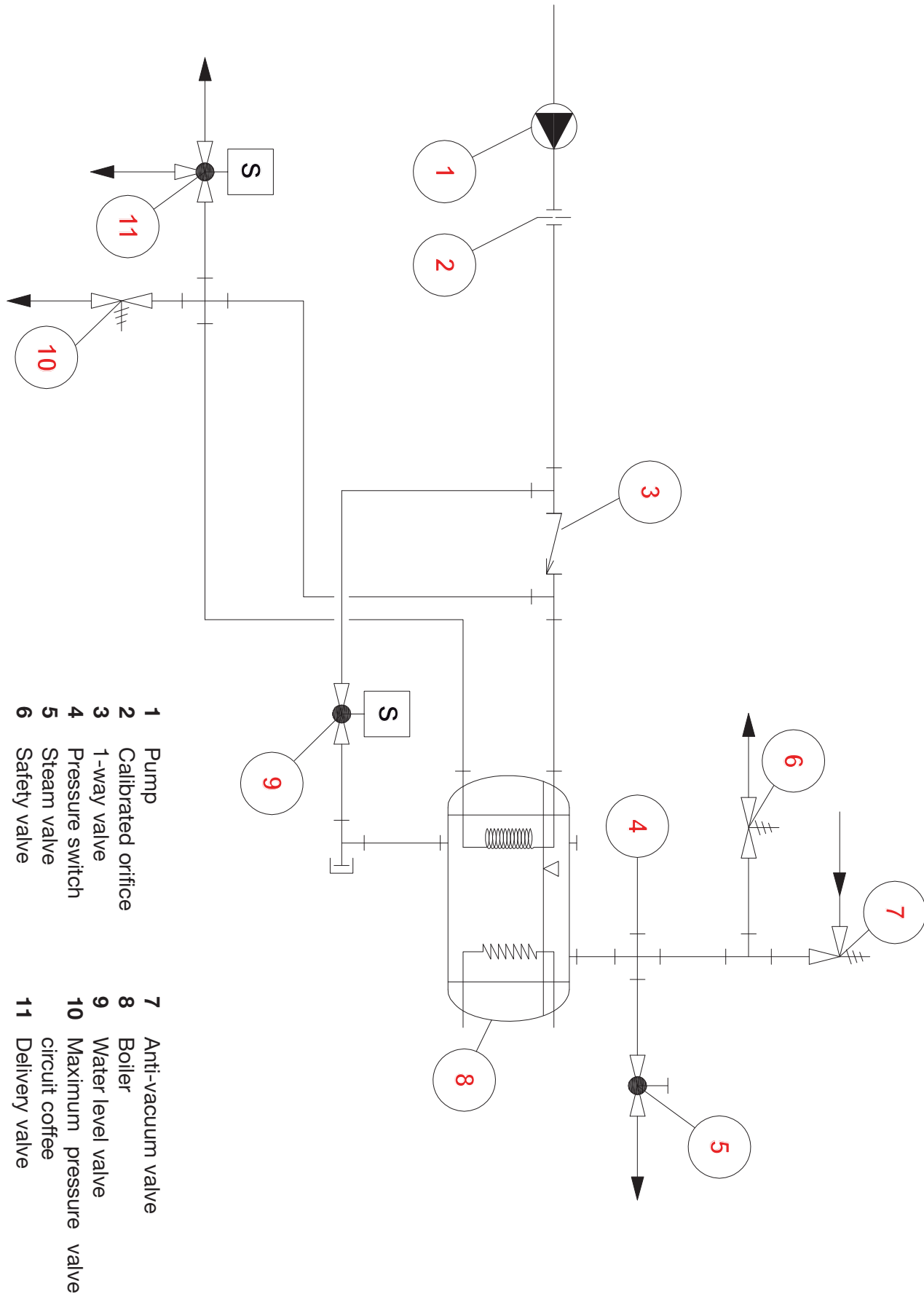
9. DIAGRAMS



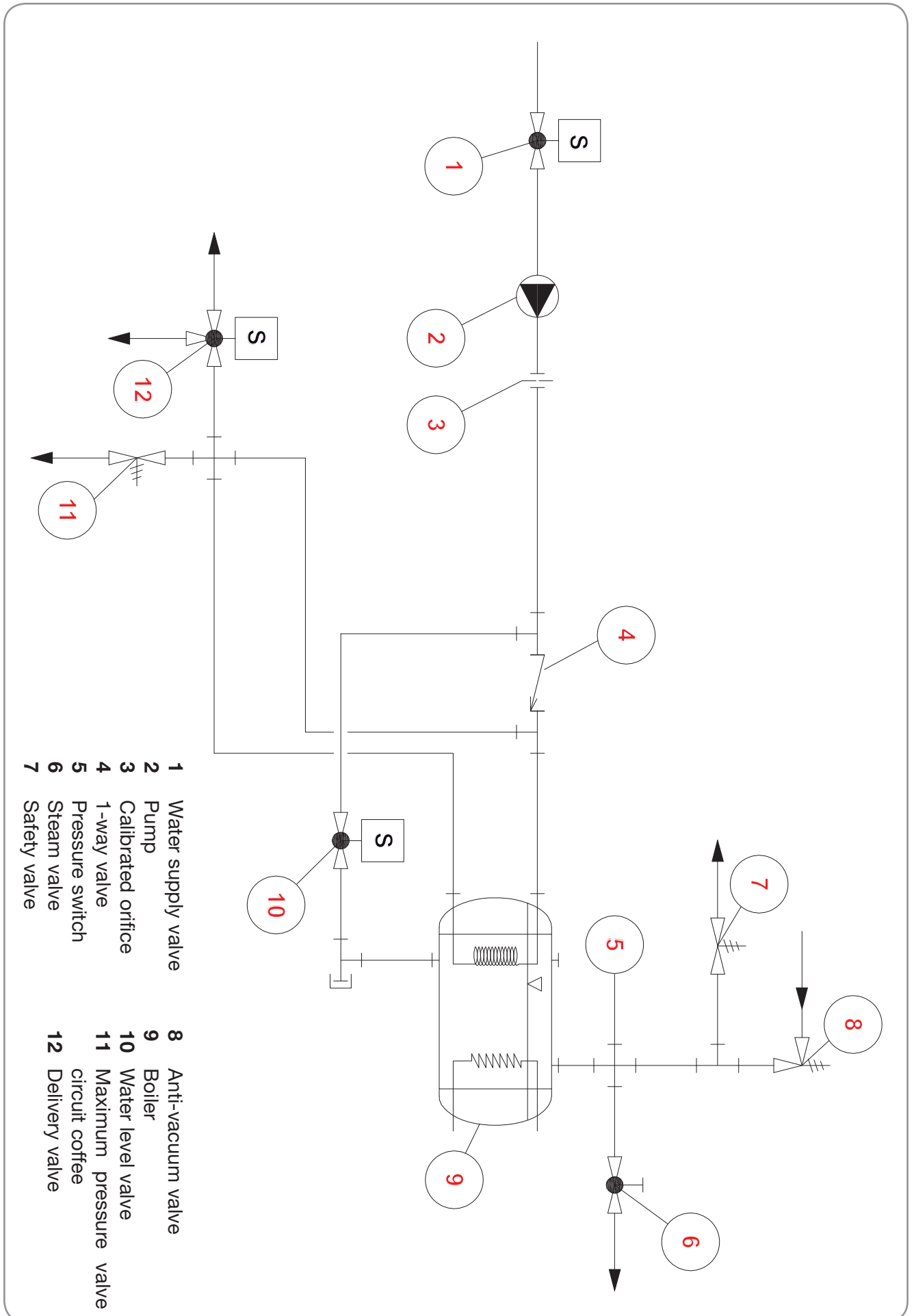
INDEX

9. DIAGRAMS	9.1
9.1 HYDRAULIC DIAGRAM	
TANK VERSION	9.2
9.2 HYDRAULIC DIAGRAM	
DIRECT CONNECTION VERSION ...	9.3
9.3 WIRING DIAGRAM TANK VERSION. .	9.4
9.4 WIRING DIAGRAM DIRECT	
CONNECTION VERSION.....	9.5

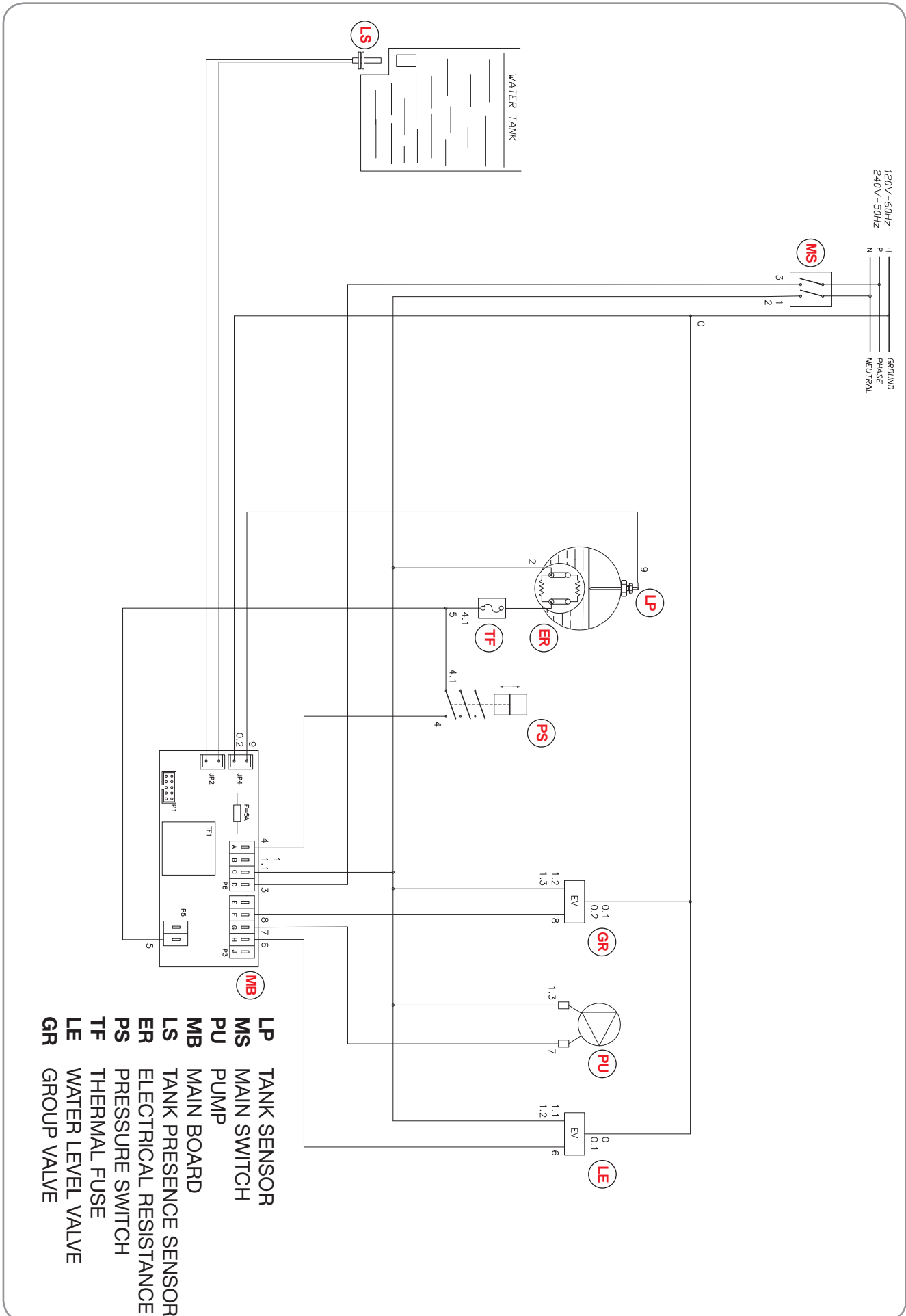
9.1 HYDRAULIC DIAGRAM TANK VERSION



9.2 HYDRAULIC DIAGRAM DIRECT CONNECTION VERSION

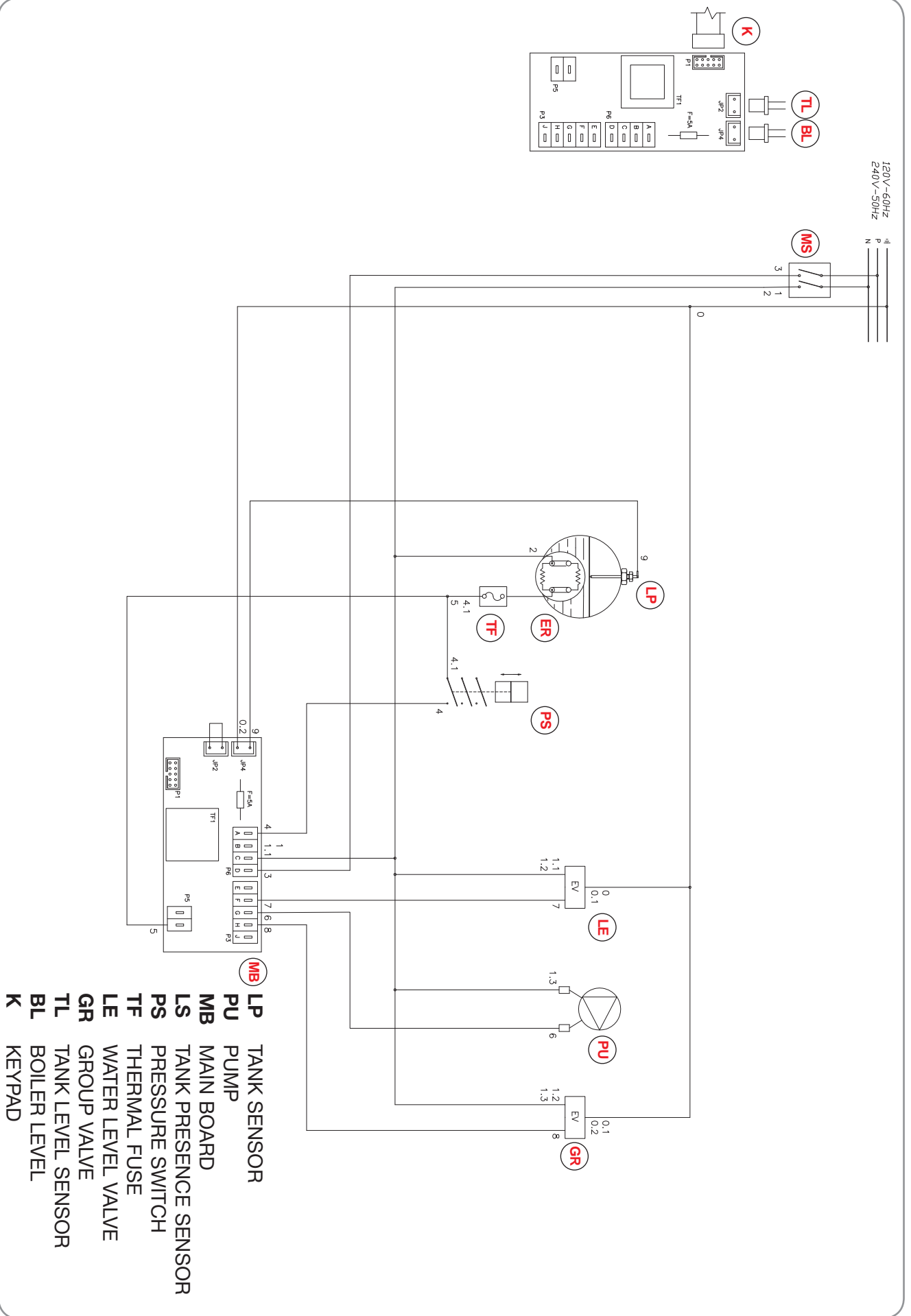


9.3 WIRING DIAGRAM TANK VERSION



- LP TANK SENSOR
- MS MAIN SWITCH
- PU PUMP
- MB MAIN BOARD
- LS TANK PRESENCE SENSOR
- ER ELECTRICAL RESISTANCE
- PS PRESSURE SWITCH
- TF THERMAL FUSE
- LE WATER LEVEL VALVE
- GR GROUP VALVE

9.4 WIRING DIAGRAM DIRECT CONNECTION VERSION



- LP** TANK SENSOR
- PU** PUMP
- MB** MAIN BOARD
- LS** TANK PRESENCE SENSOR
- PS** PRESSURE SWITCH
- TF** THERMAL FUSE
- LE** WATER LEVEL VALVE
- GR** GROUP VALVE
- TL** TANK LEVEL SENSOR
- BL** BOILER LEVEL
- K** KEYPAD

10. MAINTENANCE CHECKING



INDEX

10. MAINTENANCE CHECKING	10.1
10.1 DAILY MAINTENANCE	10.2
10.2 WEEKLY MAINTENANCE	10.2
10.3 YEARLY MAINTENANCE	10.3
10.4 BIENNIAL MAINTENANCE	10.4

10.1 DAILY MAINTENANCE

Time required 5 min:

- Clean the machine;
- Clean the unit with the blind filter and specific detergent (Pulycaff);
- Empty the water collection tray.

10.2 WEEKLY MAINTENANCE

Time required 10 min:

- Clean the machine;
- Clean the unit with the blind filter and specific detergent (Pulycaff);
- Empty the water collection tray;
- Remove the filter from its holder and thoroughly clean it;
- Immerse the filter holder into hot water with specific detergent (Pulycaff) and thoroughly clean all parts;
- Verify suitability of water used (total hardness $F^{\circ} < 6$).

10.3 YEARLY MAINTENANCE

Time required 45 - 60 min:

The skilled technician should take all the necessary precautions concerning safety measures to insulate the machine from the mains and to avoid pressure in the heater, waterline closure or tank removal so as to prevent inconveniences or damages. Before proceeding, remove all machine covers and check for any damage or leakage.

Before proceeding, remove all perimeter coverings and make sure there are no damages or leakages.

- Check for any sign of leakage;
- Check all wirings;
- Check pump noise;
- Check for any drip from the unit and the steam nozzle;
- Check non-return valve;
- Check self-level function;
- Check heater pressure (_____Bar);
- Check the presence of limescale in the tank;
- Check electrovalve for leakages;
- Check heater for leakages;
- Replace the group gasket (02280020.C);
- Replace shower screen (03000066);
- Insert or replace, if necessary, shims under the seal (02060014).



NOTES

The water hardness must be below 6°fr (French degree).

The chlorine content must not exceed 100 mg.

Necessary spare parts:

02280020.C

03000066

02060014

10.4 BIENNIAL MAINTENANCE

Time required 60 - 90 min:

The skilled technician should take all the necessary precautions concerning safety measures to insulate the machine from the mains and to avoid pressure in the heater, waterline closure or tank removal so as to prevent inconveniences or damages. Before proceeding, remove all machine covers and check for any damage or leakage.

- Check for any sign of leakage;
- Check all wirings;
- Check pump noise;
- Check for any drip from the unit, the steam nozzle and the hot water nozzle;
- Replace the non-return valve (01000023);
- Check self-level function;
- Check heater pressure (_____Bar);
- Check total production of beverages;
- Check electrovalve for leakages;
- Check heater for leakages;
- Replace group gasket (02280020.C);
- Replace shower screen (03000066);
- Insert or replace, if necessary, shims under the seal (02060014);
- Replace the pressure switch (09200014);
- Replace the steam nozzle seals (05000001);
- Replace the steam nozzle closing piston (98008004);
- Replace the 2-coffee filter (03000073);
- Replace the 1-coffee filter (03000072);
- Replace the steam nozzle support seal (02280037);
- Replace the nozzle support seal (02280011);
- Replace the steam lever piston seals (2 x 02280014);
- Replace the steam nozzle seal (02280036);
- Replace the unit expansion valve (98120001).



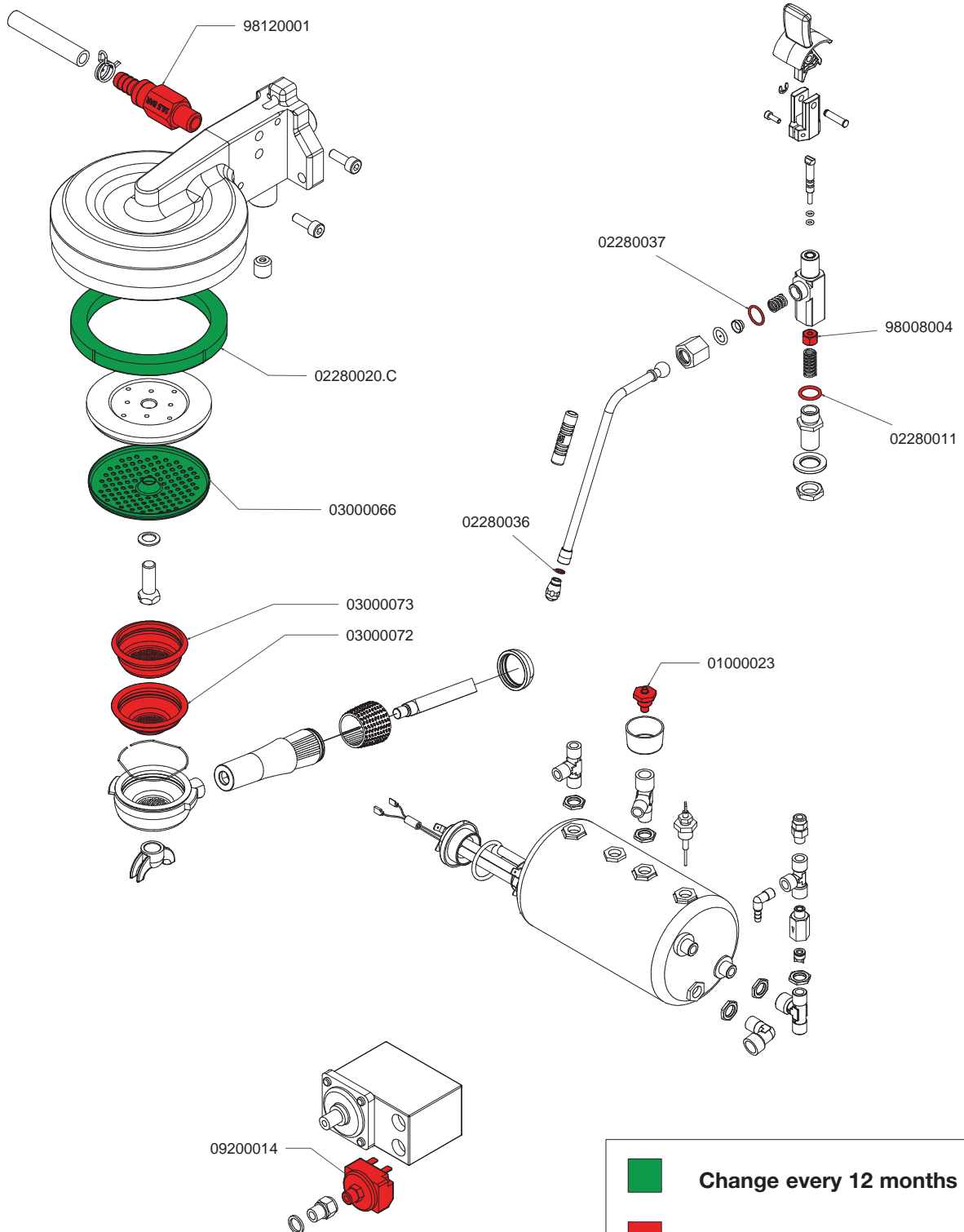
NOTES

**The water hardness must be below 6°fr (French degree).
The chlorine content must not exceed 100 mg.**

Necessary spare parts:

01000023
02280020.C
03000066
02060014
09200014
05000001
98008004
03000073
03000072
02280037
02280011
2x02280014
02280036
98120001

ANNUAL MAINTENANCE



Change every 12 months

Change every 24 months



11. SPARE PART CATALOGUE

COMPONENTI GRUPPO CARENA CABINET PARTS

* SPECIFICARE COLORE (SPECIFY COLOR)

nuova SIMONELLI

TAV 01

REFERENCE	DESCRIPTION	DESCRIPTION	END VARIETY
00000009	VIS AUTOP 3x6x2.8. M10. TC TOR	SCREW SELF-TAPPING SCREW 3.0x6.5 M10x2.8	O S C A R I I
00000011	MONDILE DI RIVESTIMENTO IN ALLUMINIO	ALUMINUM COVER	
00000047	VIS AUTOP 2.5x6.5 TOR C6	SCREW HEAD CAP SELF-TAPPING SCREW 2.5x6.5 TOR C6	
00000050	VIS AUTOP 2.5x6.5 TOR C6	SCREW HEAD CAP SELF-TAPPING SCREW 2.5x6.5 TOR C6	
00000053	MONDILE DI RIVESTIMENTO IN ALLUMINIO	ALUMINUM COVER	
00000056	MONDILE DI RIVESTIMENTO IN ALLUMINIO	ALUMINUM COVER	
00000112	VIS INOX M4x16 TOR D16	SS HEX SCREW TOR D16 M4x16	
00000118	VIS INOX M4x16 TOR D16	SS HEX SCREW TOR D16 M4x16	
00000150	VIS INOX M4x16 TOR D16	SS HEX SCREW TOR D16 M4x16	
00000174	VIS INOX M4x16 TOR D16	SS HEX SCREW TOR D16 M4x16	
00000175	VIS INOX M4x16 TOR D16	SS HEX SCREW TOR D16 M4x16	
00000199	VIS PORTAFILTRO INOX M4x16 TOR D16	SS PORTAFILTRO INOX M4x16 TOR D16	
00000204	MONDILE DI RIVESTIMENTO IN ALLUMINIO	ALUMINUM COVER	
00000221	MONDILE DI RIVESTIMENTO IN ALLUMINIO	ALUMINUM COVER	
00000222	MONDILE DI RIVESTIMENTO IN ALLUMINIO	ALUMINUM COVER	
00000223	MONDILE DI RIVESTIMENTO IN ALLUMINIO	ALUMINUM COVER	
00000224	MONDILE DI RIVESTIMENTO IN ALLUMINIO	ALUMINUM COVER	
00000225	MONDILE DI RIVESTIMENTO IN ALLUMINIO	ALUMINUM COVER	
00000226	MONDILE DI RIVESTIMENTO IN ALLUMINIO	ALUMINUM COVER	
00000227	MONDILE DI RIVESTIMENTO IN ALLUMINIO	ALUMINUM COVER	
00000228	MONDILE DI RIVESTIMENTO IN ALLUMINIO	ALUMINUM COVER	
00000229	MONDILE DI RIVESTIMENTO IN ALLUMINIO	ALUMINUM COVER	
00000230	MONDILE DI RIVESTIMENTO IN ALLUMINIO	ALUMINUM COVER	
00000231	MONDILE DI RIVESTIMENTO IN ALLUMINIO	ALUMINUM COVER	
00000232	MONDILE DI RIVESTIMENTO IN ALLUMINIO	ALUMINUM COVER	
00000233	MONDILE DI RIVESTIMENTO IN ALLUMINIO	ALUMINUM COVER	
00000234	MONDILE DI RIVESTIMENTO IN ALLUMINIO	ALUMINUM COVER	
00000235	MONDILE DI RIVESTIMENTO IN ALLUMINIO	ALUMINUM COVER	
00000236	MONDILE DI RIVESTIMENTO IN ALLUMINIO	ALUMINUM COVER	
00000237	MONDILE DI RIVESTIMENTO IN ALLUMINIO	ALUMINUM COVER	
00000238	MONDILE DI RIVESTIMENTO IN ALLUMINIO	ALUMINUM COVER	
00000239	MONDILE DI RIVESTIMENTO IN ALLUMINIO	ALUMINUM COVER	
00000240	MONDILE DI RIVESTIMENTO IN ALLUMINIO	ALUMINUM COVER	
00000241	MONDILE DI RIVESTIMENTO IN ALLUMINIO	ALUMINUM COVER	
00000242	MONDILE DI RIVESTIMENTO IN ALLUMINIO	ALUMINUM COVER	
00000243	MONDILE DI RIVESTIMENTO IN ALLUMINIO	ALUMINUM COVER	
00000244	MONDILE DI RIVESTIMENTO IN ALLUMINIO	ALUMINUM COVER	
00000245	MONDILE DI RIVESTIMENTO IN ALLUMINIO	ALUMINUM COVER	
00000246	MONDILE DI RIVESTIMENTO IN ALLUMINIO	ALUMINUM COVER	
00000247	MONDILE DI RIVESTIMENTO IN ALLUMINIO	ALUMINUM COVER	
00000248	MONDILE DI RIVESTIMENTO IN ALLUMINIO	ALUMINUM COVER	
00000249	MONDILE DI RIVESTIMENTO IN ALLUMINIO	ALUMINUM COVER	
00000250	MONDILE DI RIVESTIMENTO IN ALLUMINIO	ALUMINUM COVER	
00000251	MONDILE DI RIVESTIMENTO IN ALLUMINIO	ALUMINUM COVER	
00000252	MONDILE DI RIVESTIMENTO IN ALLUMINIO	ALUMINUM COVER	
00000253	MONDILE DI RIVESTIMENTO IN ALLUMINIO	ALUMINUM COVER	
00000254	MONDILE DI RIVESTIMENTO IN ALLUMINIO	ALUMINUM COVER	
00000255	MONDILE DI RIVESTIMENTO IN ALLUMINIO	ALUMINUM COVER	
00000256	MONDILE DI RIVESTIMENTO IN ALLUMINIO	ALUMINUM COVER	
00000257	MONDILE DI RIVESTIMENTO IN ALLUMINIO	ALUMINUM COVER	
00000258	MONDILE DI RIVESTIMENTO IN ALLUMINIO	ALUMINUM COVER	
00000259	MONDILE DI RIVESTIMENTO IN ALLUMINIO	ALUMINUM COVER	
00000260	MONDILE DI RIVESTIMENTO IN ALLUMINIO	ALUMINUM COVER	
00000261	MONDILE DI RIVESTIMENTO IN ALLUMINIO	ALUMINUM COVER	
00000262	MONDILE DI RIVESTIMENTO IN ALLUMINIO	ALUMINUM COVER	
00000263	MONDILE DI RIVESTIMENTO IN ALLUMINIO	ALUMINUM COVER	
00000264	MONDILE DI RIVESTIMENTO IN ALLUMINIO	ALUMINUM COVER	
00000265	MONDILE DI RIVESTIMENTO IN ALLUMINIO	ALUMINUM COVER	
00000266	MONDILE DI RIVESTIMENTO IN ALLUMINIO	ALUMINUM COVER	
00000267	MONDILE DI RIVESTIMENTO IN ALLUMINIO	ALUMINUM COVER	
00000268	MONDILE DI RIVESTIMENTO IN ALLUMINIO	ALUMINUM COVER	
00000269	MONDILE DI RIVESTIMENTO IN ALLUMINIO	ALUMINUM COVER	
00000270	MONDILE DI RIVESTIMENTO IN ALLUMINIO	ALUMINUM COVER	
00000271	MONDILE DI RIVESTIMENTO IN ALLUMINIO	ALUMINUM COVER	
00000272	MONDILE DI RIVESTIMENTO IN ALLUMINIO	ALUMINUM COVER	
00000273	MONDILE DI RIVESTIMENTO IN ALLUMINIO	ALUMINUM COVER	
00000274	MONDILE DI RIVESTIMENTO IN ALLUMINIO	ALUMINUM COVER	
00000275	MONDILE DI RIVESTIMENTO IN ALLUMINIO	ALUMINUM COVER	
00000276	MONDILE DI RIVESTIMENTO IN ALLUMINIO	ALUMINUM COVER	
00000277	MONDILE DI RIVESTIMENTO IN ALLUMINIO	ALUMINUM COVER	
00000278	MONDILE DI RIVESTIMENTO IN ALLUMINIO	ALUMINUM COVER	
00000279	MONDILE DI RIVESTIMENTO IN ALLUMINIO	ALUMINUM COVER	
00000280	MONDILE DI RIVESTIMENTO IN ALLUMINIO	ALUMINUM COVER	
00000281	MONDILE DI RIVESTIMENTO IN ALLUMINIO	ALUMINUM COVER	
00000282	MONDILE DI RIVESTIMENTO IN ALLUMINIO	ALUMINUM COVER	
00000283	MONDILE DI RIVESTIMENTO IN ALLUMINIO	ALUMINUM COVER	
00000284	MONDILE DI RIVESTIMENTO IN ALLUMINIO	ALUMINUM COVER	
00000285	MONDILE DI RIVESTIMENTO IN ALLUMINIO	ALUMINUM COVER	
00000286	MONDILE DI RIVESTIMENTO IN ALLUMINIO	ALUMINUM COVER	
00000287	MONDILE DI RIVESTIMENTO IN ALLUMINIO	ALUMINUM COVER	
00000288	MONDILE DI RIVESTIMENTO IN ALLUMINIO	ALUMINUM COVER	
00000289	MONDILE DI RIVESTIMENTO IN ALLUMINIO	ALUMINUM COVER	
00000290	MONDILE DI RIVESTIMENTO IN ALLUMINIO	ALUMINUM COVER	
00000291	MONDILE DI RIVESTIMENTO IN ALLUMINIO	ALUMINUM COVER	
00000292	MONDILE DI RIVESTIMENTO IN ALLUMINIO	ALUMINUM COVER	
00000293	MONDILE DI RIVESTIMENTO IN ALLUMINIO	ALUMINUM COVER	
00000294	MONDILE DI RIVESTIMENTO IN ALLUMINIO	ALUMINUM COVER	
00000295	MONDILE DI RIVESTIMENTO IN ALLUMINIO	ALUMINUM COVER	
00000296	MONDILE DI RIVESTIMENTO IN ALLUMINIO	ALUMINUM COVER	
00000297	MONDILE DI RIVESTIMENTO IN ALLUMINIO	ALUMINUM COVER	
00000298	MONDILE DI RIVESTIMENTO IN ALLUMINIO	ALUMINUM COVER	
00000299	MONDILE DI RIVESTIMENTO IN ALLUMINIO	ALUMINUM COVER	
00000300	MONDILE DI RIVESTIMENTO IN ALLUMINIO	ALUMINUM COVER	

INDEX

11. SPARE PART CATALOGUE 11.1

11.1 CABINET PARTS 11.2

11.2 COMPLETE POURING UNIT 11.3

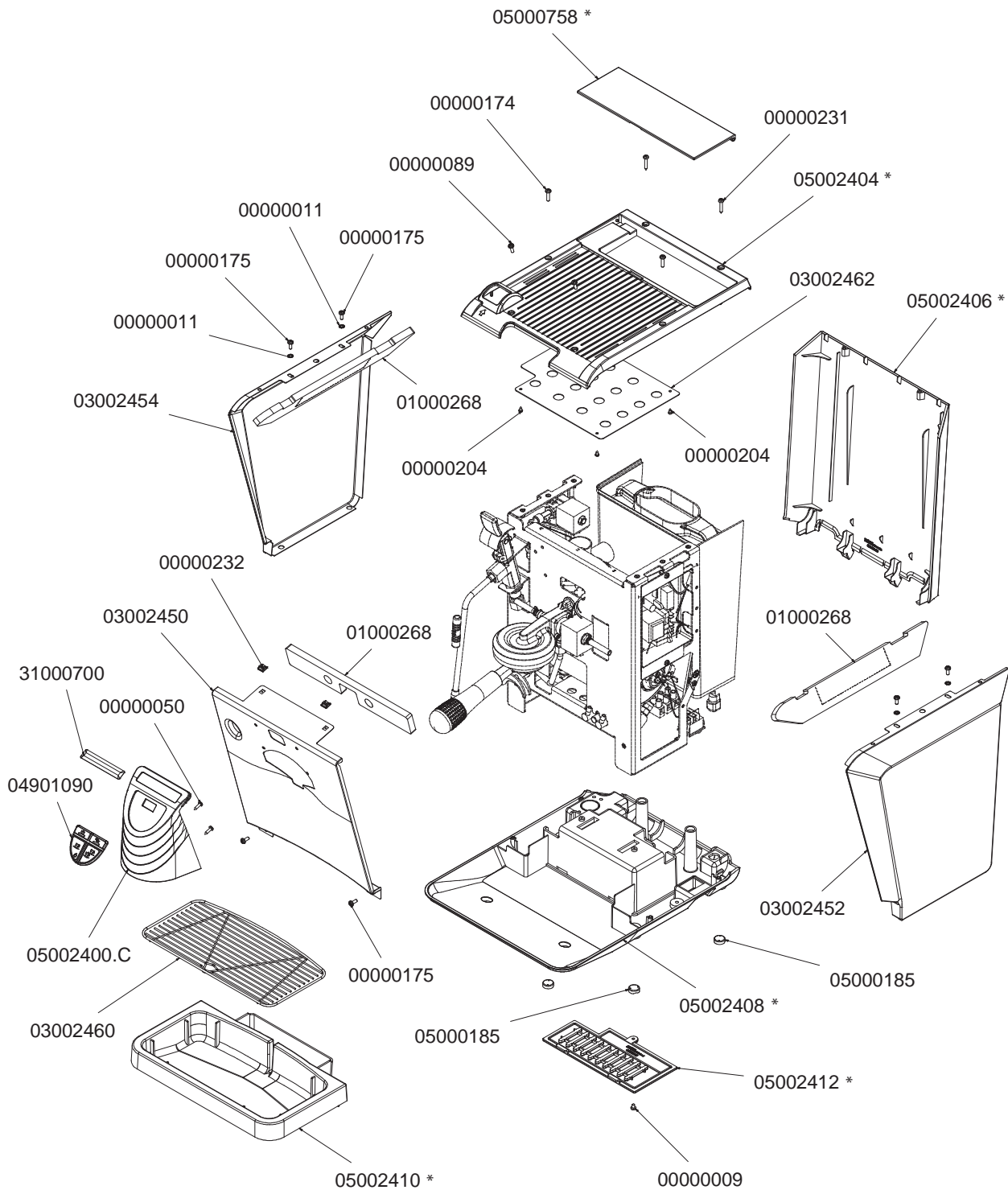
11.3 TANK - FRAME COMPONENTS 11.4

11.4 STOVE FILED COLLECT WATER 11.5

11.5 BOILER COMPONENTS 11.6

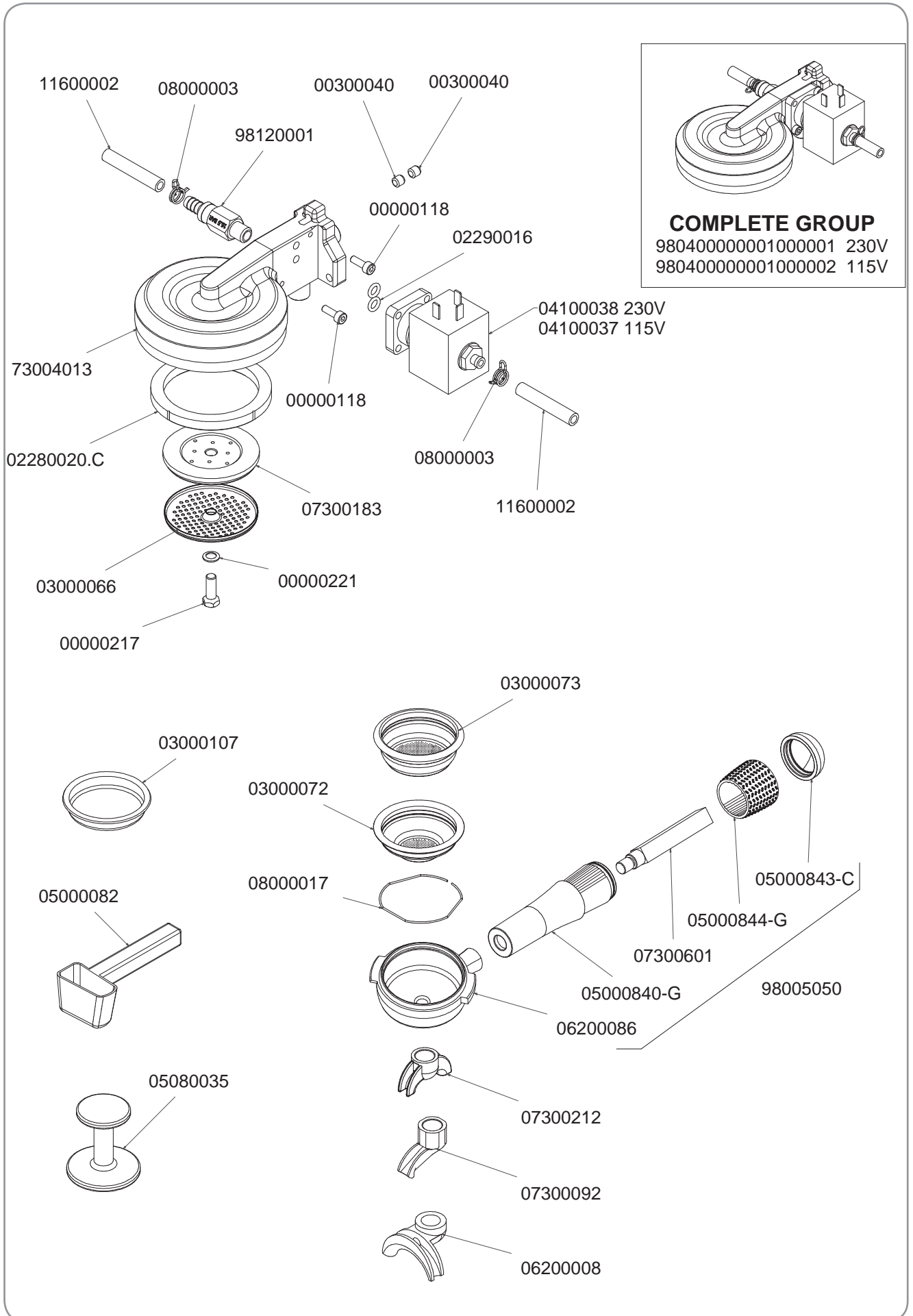
11.6 ELECTRICAL COMPONENTS 11.7

11.1 CABINET PARTS

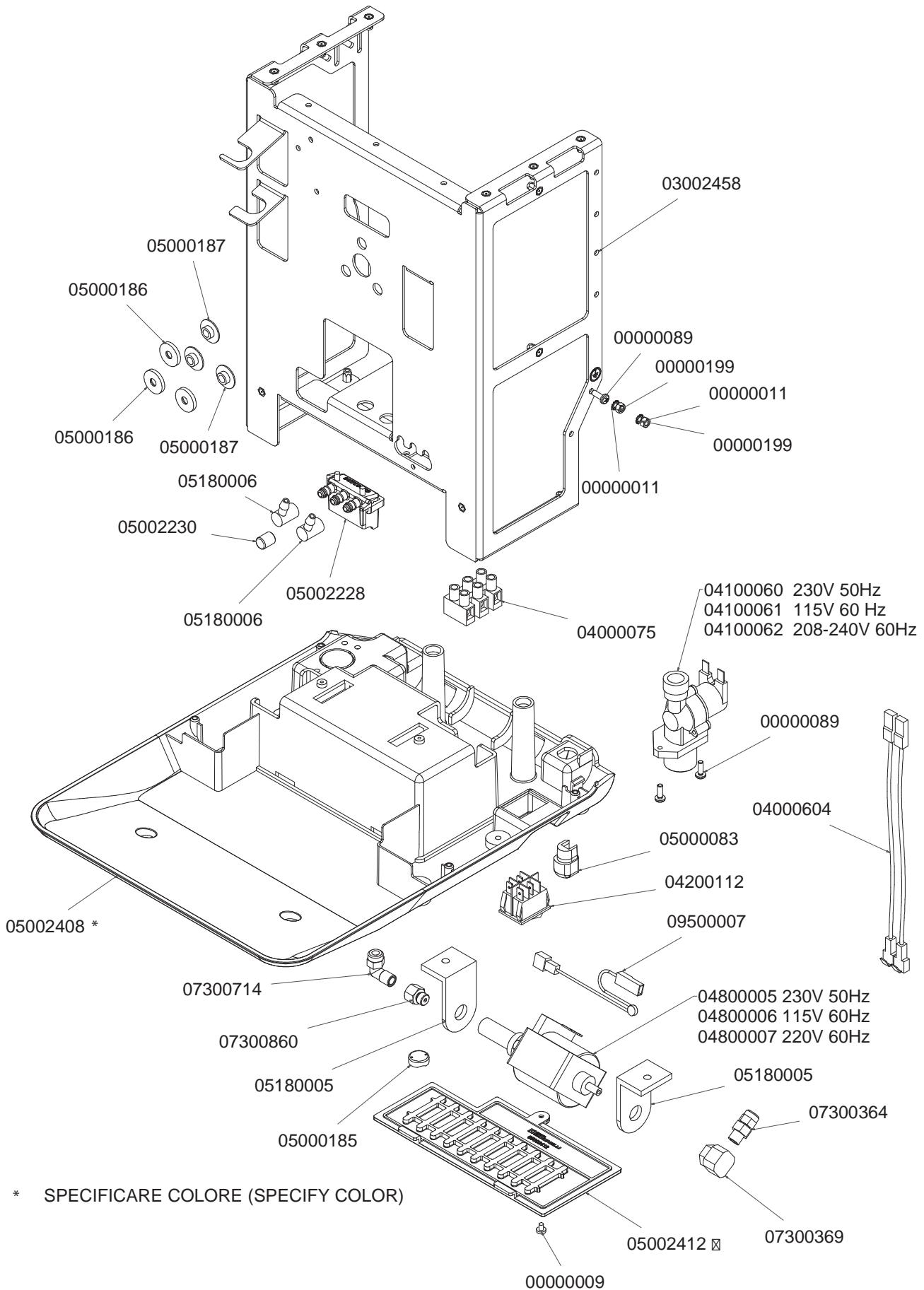


* SPECIFICARE COLORE (SPECIFY COLOR)

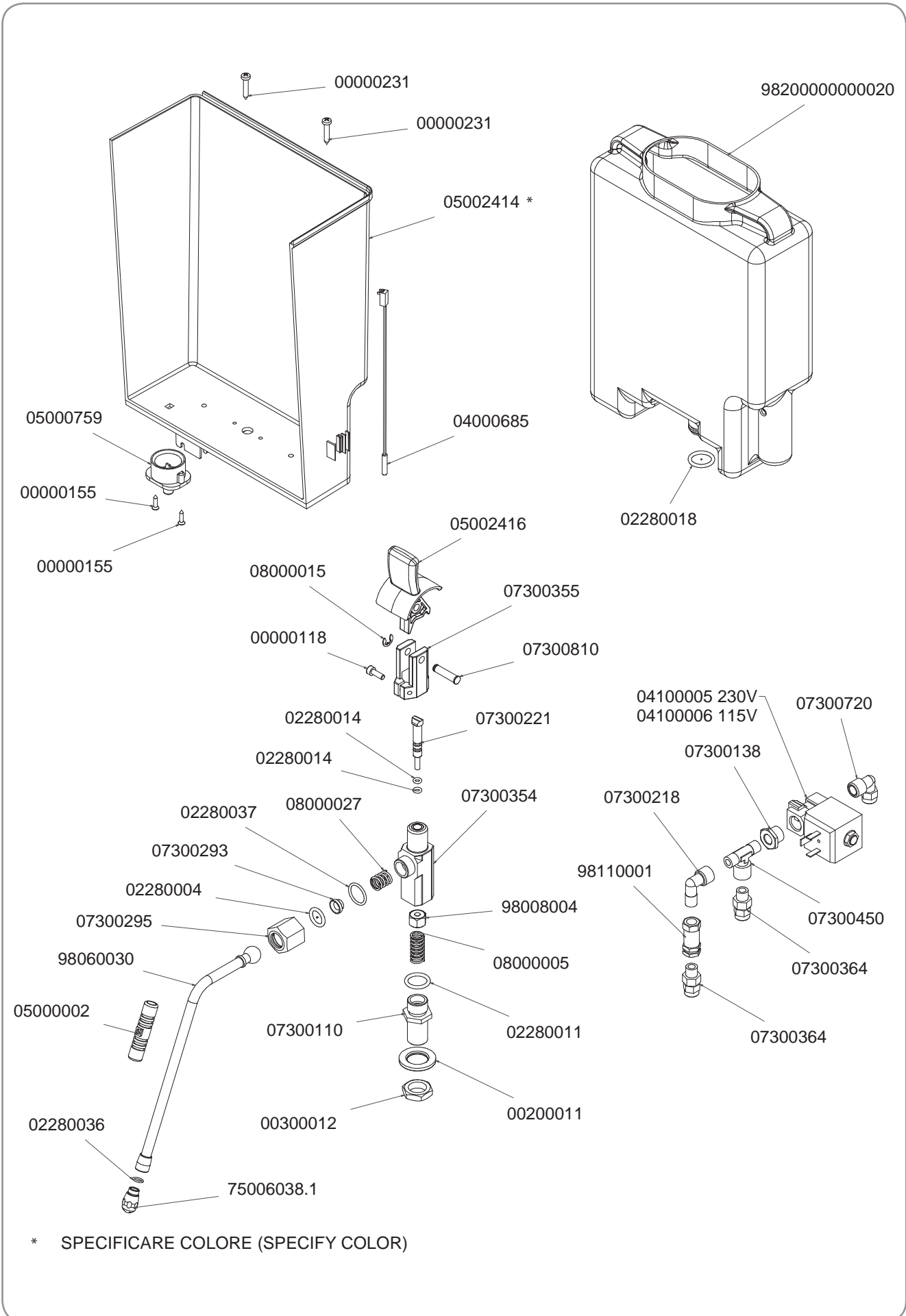
11.2 COMPLETE POURING UNIT



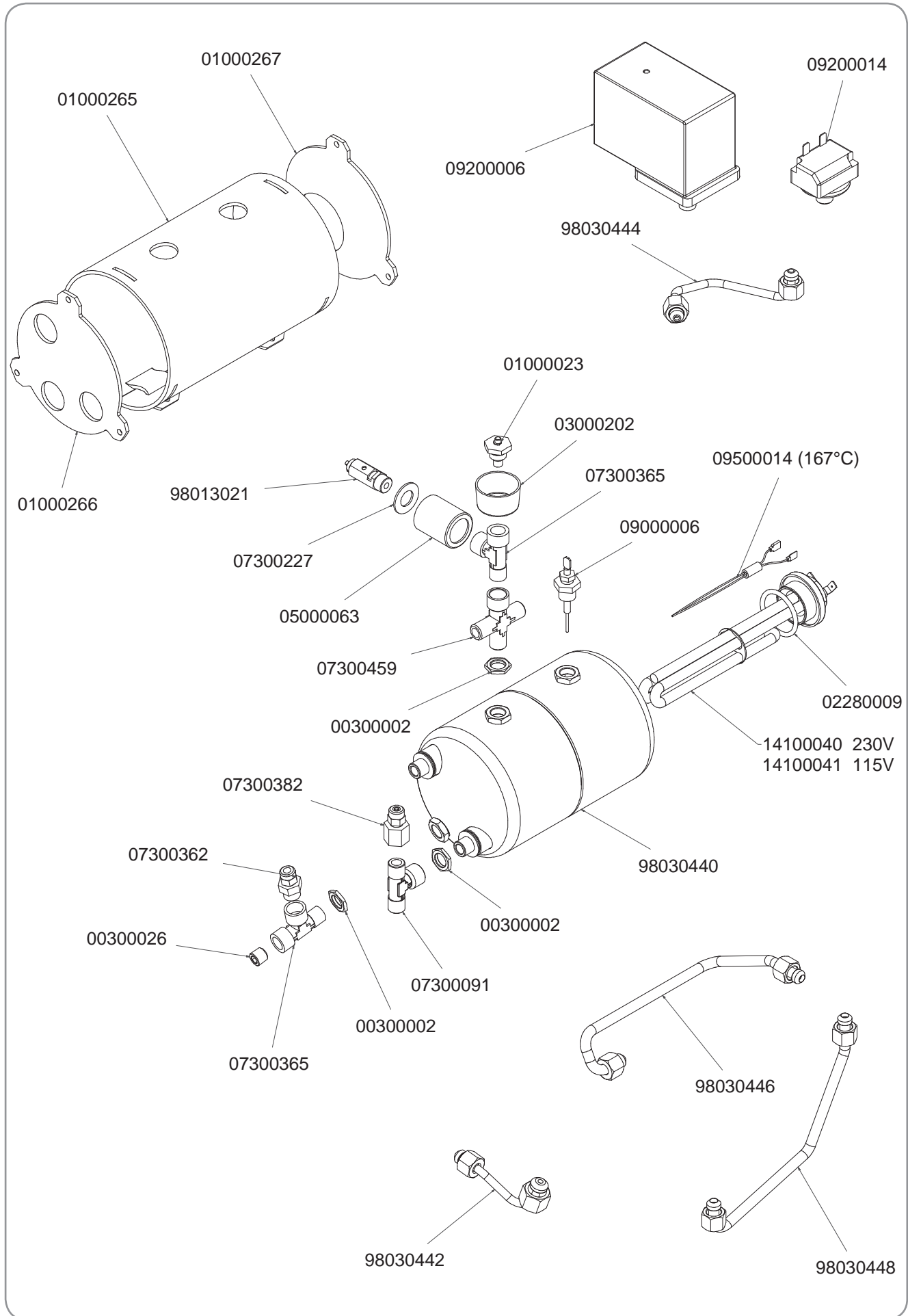
11.3 TANK - FRAME COMPONENTS



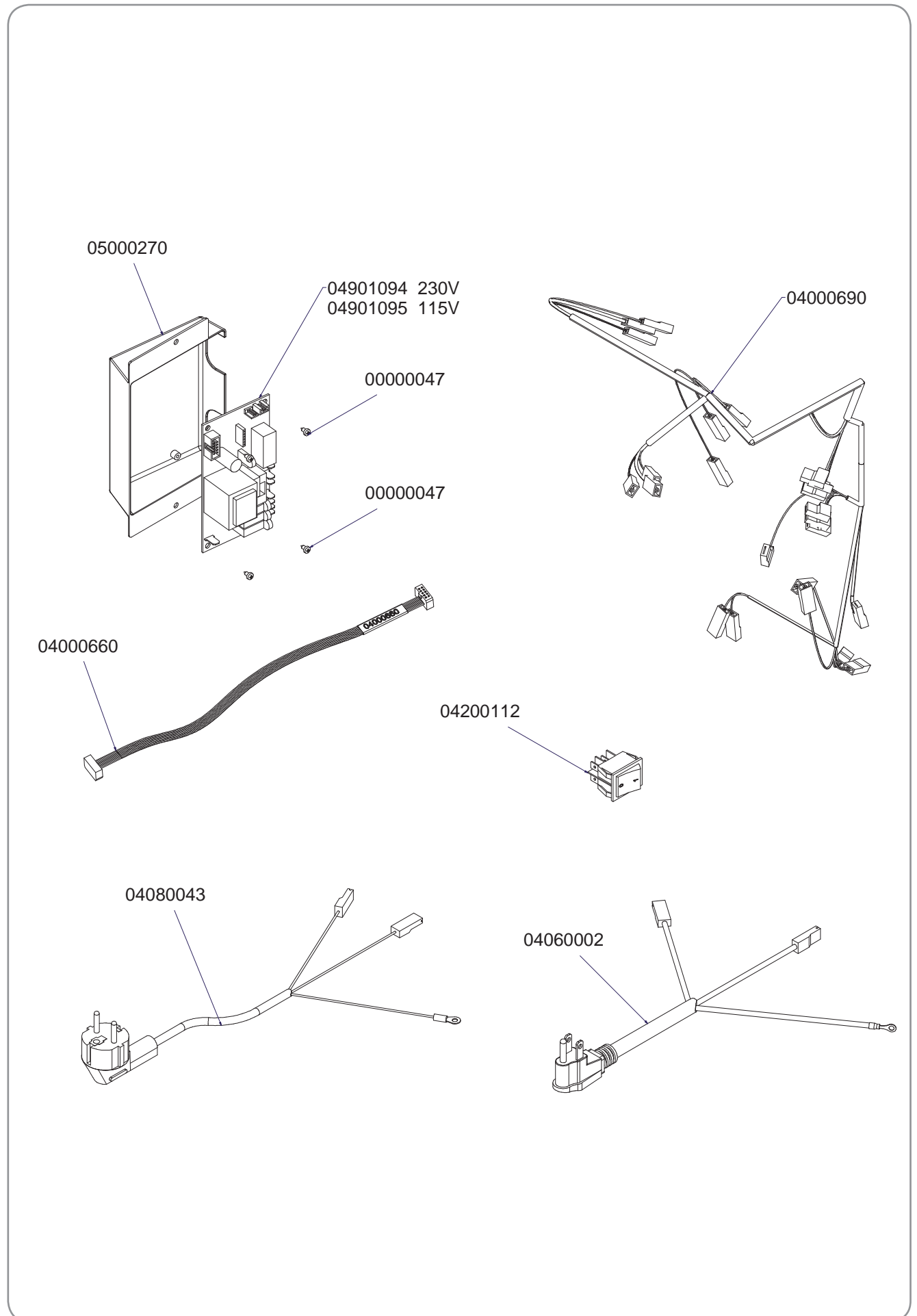
11.4 STOVE FILED COLLECT WATER



11.5 BOILER COMPONENTS



11.6 ELECTRICAL COMPONENTS



REFERENCE	DESCRIPTION	DESCRIPTION	END VALIDITY
00000009	VIS AUTOF 3,5x8 Z.B. HILO TC TCR	GALV. SELF-TAPPING SCREW 3,5x6,5 MUSTAD	O S C A R I I
00000011	RONDELLE INOX M4 MOLETEE UNI 8842/A	STAINLESS STEEL KNURLED WASHER D4	
00000047	VIS AUTOF 2,9x6,5 TC/T.CR.	CROSS HEAD CAP SELF-TAPPING SCREW 2,9x6,5	
00000050	VIS AUTOF 3,5x12 TC/T.CR.	SCREW 3,5x12 TC/T.CR.	
00000083	VIS AUTOF 3,9x16 TC/T.CR.	CROSS HEAD CAP SELF-TAPPING SCREW 3,9x16	
00000089	VIS INOX M4x12 TC TCR DEN7985	SS CROSS HEAD CAP SCREW M4x12	
00000096	RONDELLE AQ M6 6,6x18x1,5 GALVANISE	GALVANISED WASHER M6 6,6x18x1,5	
00000112	VIS INOX M6x20 TCEI UNI 5931	SS SOCKET SCREW M6x20 UNI 5931	
00000118	VIS INOX M4x12 TCEI 5931	SS HEX SOCKET CAP SCREW M4x12	
00000155	VIS INOX TRUCIOL. 3x12 TSPTCR 18-8 DEN 7505 A	SS SCREW 3x12 TSPTCR DEN 7505 A	
00000174	VIS INOX M4x16 TC TCR	SS CROSSHEAD CAP SCREW M4x16	
00000175	VIS INOX M4x10 TC TCR	SS CROSS HEAD CAP SCREW M4x10	
00000199	VIS POINTEAU INOX M4 MEDEO UNI 5588	NUT M4 MEDEUM STAINLESS UNI 5588	
00000204	VIS AUTOF INOX 2,9x6,5 TC TCR DEN7981	SS SELF-THREADENG SCREW 2,9x6,5 TC-TCR DEN7981	
00000221	RONDELLE DE SECURITE INOX M6 SCHNORR CONIQUE	SECURITY FLAT WASHER INOX M6 CONIQUEL	
00000222	VIS INOX M6 LT=17,5 TE CH9 + TC x DOCCIA **AD EPUISEE	SS SCREW M6 TE CH9 FOR GROUP SHOWER	
00000231	VIS AUTOF INOX 3,9x19 TC /TCR	SS SELF-THREADENG SCREW 3,9x22	
00000232	VIS POINTEAU CAGE M 4 x EPAI. 0,3-0,9	CAGE NUT FOR 0,3-0,9mm METAL SHEET	
00200011	RONDELLE AQ M16 17X30X3 GALVANISE	GALVANISED WASHER M16 17x30x3	
00300002	VIS POINTEAU OT 1/4 EPAI.3 CH18 AGG. 22.07.96	BRASS NUT 1/4 EPAIOR 3	
00300012	VIS POINTEAU OT 3/8 GAS CH22 EPAI.6 AGG. 22.07.96	BRASS NUT 3/8 GAS EPAIOR 6 HEX 22	
00300021	VIS INOX M6x18 TSP TC DEN963	SS SLOTTED COUNTERSUNK SCREW M6x18 DEN963	
00300026	BOUCHON CONIQUE 1/4 GAS	CONIQUEL TAP 1/4"	
00300040	VIS A TETE INOX M6x6 POINTE PLANE	SS GRUB SCREW M6x6	
01000023	PETITE VALVE MISE A L'AIR	ANTI VACUUM VALVE	
01000089	PETITE VALVE DE RETENUE CO14	RETAINING VALVE CO14	
01000092	TUYAU ALIMENTATION EAU 1,5mt EPDM 3/8F OTT. - 3/4F90	3/8F-3/4F90° WATER CHARGE PIPE 1,5mt	
01000265	ISOLANT CHAUDIERE OSCAR II	BOILER THERMAL INSULATION	
01000266	ISOLANT D.110 DX CHAUDIERE OSCAR II	BOILER THERMAL INSULATION DX SIDE	
01000267	ISOLANT D.110 SX CHAUDIERE OSCAR II	BOILER THERMAL INSULATION SX SIDE	
01000268	KIT ISOLANT CARENAGE OSCAR II	SS HULL THERMAL INSULATION	
02280004	JOINT OR 115 D.17 EP856 SNODO LANCE	GASKET OR 115 D17 EP 856 x SWIVEL STEAM PIPE	
02280009	JOINT OR 139/4131 D.40 EP851	GASKET OR 139/4131 D.40 EP851	
02280011	JOINT OR R11 D19 EP 851	GASKET O RING R11 D19 EP 851	
02280014	JOINT OR D7 AN2/OR102 SILICON 7XL1715	GASKET O RING D.7 AN2/OR102 SILICON	
02280018	JOINT OR R11 D19 SILICONE ROUGE Sh70	RED SILICON GASKET O RING Sh70	
02280020.C	JOINT. SOUCOUBE 073X058X7 TYPE C 82/84 Sha	GROUP GASKET	
02280036	JOINT OR x BEC LANCE VAP. DE 6x1.2 EPDM70	GASKET OR x STEAM WAND NOZZLE	
02280037	JOINT OR FERMETURE SNODO 16x2 NBR70	GASKET OR JOINT LOCK 16x2	
02290016	JOINT OR D 9,5 R5 SILICONE R.	GASKET OR D 9,5 R5 SILICON RED	
02590010	JOINT PISTON FKM NOIRE Sh80	GUARNIZ.PISTONCINO FKM NOIRE Sh80	
03000066	DOUCHETTE INOX 56x5,5x 6 SOUDEE Aisi304	SHOWER INOX 056X05,5X6	
03000072	FILTRE 1 CAFE' ALTO 7 gr.	FILTER ONE COFFEE HIGH REPLACE 03000321	
03000073	FILTRE 2 CAFE' ALTO 14gr.	FILTER TWO COFFEE HIGH REPLACE 03000322	
03000202	RESERVOIR RACC.CONDENSEA MASTER AGG. 07.06.97	CONDENSATION TRAY MASTER	
03002450	CARENAGE FRONTAL OSCAR II	FRONT PANEL OSCAR II	
03002452	CARENAGE FLANC DROIT OSCAR II	RIGHT SIDE PANEL OSCAR II	
03002454	CARENAGE FLANC GAUCHE OSCAR II	LEFT SIDE PANEL OSCAR II	
03002458	TOLERIE MACHINE OSCAR II	MACHINE FRAME OSCAR II	
03002460	RETINA A FILO INOX PIANO LAV. OSCAR II	SS NET WORK PLANE OSCAR II	
03002462	PROTECTION. P.CHAUFFE TASSES OSCAR II	CUP WARMER INTERNAL PROTECTION OSCAR II	
04000075	CONNECTEUR PVC 2 POLES	TERMINAL BLOCK 2 WAY	
04000198	PRISE LAMELLAIRE M 6.3 d4.2 45	FOIL HOLDER M 6.3 D 4.2 45	
04000199	PRISE LAMELLAIRE DOUBLE M 6.3 d4.2 45	DOUBLE FOIL HOLDER M 6.3 D 4.2 45	
04000566	UNITE MAGNETIQUE FLOTTEUR D22X35	FLOATING UNIT	
04000660	CABLE DE CONEXION CARTE/ DISTRIBUTEUR MUSICA	CENTRAL UNIT/DESPENSING BOARD FLAT CABLE	
04000685	CAPEUR REED 4X19 x OSCAR II TANICA	TANK LEVEL REED SENSOR 4x19mm OSCAR II	
04000690	CABLAGE COMPLET OSCAR II	COMPLETE ELECTRICAL CABLING OSCAR II	
04006002	CABLE ALIM. UL AWG3x18 SJO 10A 90C 2mt PRISE USA DROITE	POWER SUPPLY CABLE UL AWG 3x18 SJT + PLUG 730	
04080043	CABLE ALIM. 2mt CE PRISE SCHUKO 90 H05VV-F 3x0,75	2 m POWER CORD EC PLUG	
04100005	E.V. NC 2VOIES 1/4-1/4 220-230V 50/60Hz EPDM F2 CE	NC 2-WAY SOLENOID 1/4-1/4	
04100006	E.V. NC 2VOIES 1/4-1/4 110-120V 60Hz EPDM F2 UL	NC 2-WAY SOLENOID 1/4-1/4 115v	
04100037	E.V. NC 3VOIES BAS VIDAGE PORTAG.115V 60Hz VITON F1.5 UL	3-WAY SOLENOID VALVE 115V 60Hz VITON F1.5 UL	
04100038	E.V. NC 3VOIES BAS VIDAGE PORTAG.230V 50/60Hz VITON F1.5	3 WAYS SOLENOID VALVE 230V	
04100060	E.V. NC 2VOIES 3/4-JG 6 DROITE PORTAG.230V 50/60Hz	2-WAY SOLENOID VALVE 3/4-JG 6 230V 50/60HZ	
04100061	E.V. NC 2VOIES 3/4-JG 6 DROITE REGUL+FILTR F.2,5 115V 60Hz UL	2-WAY SOLENOID VALVE 3/4-JG 6 115v 60HZ	
04100062	E.V. NC 2VOIES 3/4-JG6 DROITE. UL REGUL+FILTR F.2,5 208/240V60Hz	2-WAY SOLENOID VALVE 3/4-JG 6 230V 60HZ UL	
04200112	INTERRUPTEUR BIPOLAIRE ROUGE 0/1 RECTANGULAIRE UL 16A	2 POLES SWITCH 16A OSCAR II	
04800005	POMPE ELECTROMECHANIQUE. 230V 50Hz 48W	VIBRATION PUMP V230/50	
04800006	POMPE ELECTROMECHANIQUE. 120V 60Hz 41W	VIBRATION PUMP 115V 60Hz	
04800007	POMPE ELECTROMECHANIQUE 220V 60Hz 64W	ELECTROMECHANICAL PUMP 220V 60Hz 64W	
04901090	CARTE DISTRIBUTEUR 2 TOUCHES OSCARII	2 KEY KEYBOARD OSCAR II	
04901094	CARTE ELECTRONIQUE. OSCAR II 230V	CONTROL UNIT OSCAR II 230V	
04901095	CARTE ELECTRONIQUE. OSCAR II 115V	CONTROL UNIT OSCAR II 115V	
05000002	CAOUTCHOU DE PROTECTION LANCE D.8	RUBBER STEAM PIPE PROTECTION 8	
05000063	COUVRE VALVE DE SECURITE PA6	SAFETY VALVE COVER	
05000082	DOSEUR CAFE' MOULU 1 DOSE	1 DOSE SPOON	
05000083	SERRE CABLE SR 11-2 NOIRE	CABLE BLOCK SR 11-2	
05000185	PIED OSCAR	FOOT OSCAR	
05000186	INCERE NYLON GR. OSCAR h3 D.6,3/20 NOIRE	H2 NYLON INSERT OSCAR GROUP	
05000187	INCERE NYLON GR. OSCAR H1 D.6,3/20	H1 NYLON INSERT OSCAR GROUP	
05000268	RESERVOIR EAU 3lt "MUSICA"	3LT WATER CONTAINER - MUSICA	
05000270	SUPPORT CARTE DE CONTRÔLE "MUSICA"	ELECTRONIC CONTROL BOARD SUPPORT - MUSICA	
05000758.N	COUVERCLE RESERVOIR EAU 5LT PRONTOBAR NOIRE GRIS	5 LT WATER CHAMBER COVER - PRONTOBAR BLACK	
05000759	COLLECTEUR RESERVOIR EAU 5LT MICROBAR	MICROBAR WATER CONTAINER MAINFOLD 5LT	
05000840	MANETTE PORTE FILTRE 2003 NOIRE	FILTER HOLDER KNOB 2003 BLACK	
05000842	FERMETURE MANETTE PORTE FILTRE 2003	FILTER HOLDER KNOB LOCK 2003	
05000844	REVETEMENT CAOUTCHOU NOIRE MANETTE PORTE FILTRE	BLACK RUBBER COVER FILTER HOLDER KNOB	
05002228	COLLECTEUR GROUPE D'ALIMENTATION	POURING UNIT DRAIN MANIFOLD	
05002230	BOUCHON CAOUTCHOU ALIMENTATION x 05002228	DRAIN RUBBER PLUG	
05002400	COUVRE GROUPE OSCAR II	GROUP COVER OSCAR II	
05002404	CARENAGE SUPERIEUR OSCAR II	TOP COVER OSCAR II	
05002406	CARENAGE ARRIERE OSCAR II	BACK COVER OSCAR II	
05002408	CARENAGE INFERIEUR OSCAR II	BASE COVER OSCAR II	
05002410	RESERVOIR RAC.EAU OSCAR II	DRIP TRAY OSCAR II	

REFERENCE	DESCRIPTION	DESCRIPTION	END VALIDITY
05002412	FERMETURE FOND OSCAR II	BOTTOM COVER OSCAR II	O S C A R I I
05002414	SUPPORT RESERVOIR OSCAR II	TANK SUPPORT OSCAR II	
05002416	MANETTE VAPEUR OSCAR II	STEAM KNOB OSCAR II	
05080035	PRESSE CAFE' ABS NOIRE	PLASTIC COFFEE PRESS	
05180005	SUPPORT POMPE AD L	L-SHAPED PUMP BRACKET	
05180006	PIPETTE PORTE CAOUTCHOUC 90 x POMPE	SMALL PIPE	
06200008	BEC DEUX VOIES OUVERT	TWO WAYS SPOUT	
06200086	CORPS PORTE FILTRE. INCLINE 2003 PERSONALISE N.S.	TILTED FILTER HOLDER BODY 2003	
07300009	VIS POINTEAU RACCORD 1/4 GAS	NUT CONNECTION 1/4 GAS	
07300034	PISTON. 12x4,5x4	VALVE PISTON 12x4,5x4	
07300091	RACCORD T 1/4 M-F-M CILYN.	T FITTING MFM 1/4	
07300110	BOUCHON PORTE RESORT R.V. PR.	SPRING HOLDER TAP	
07300138	REDUCTION 1/4" M - 1/8" F ES.17 AGG. 29.05.96	REDUCTION 1/4"-1/8" ES, 17 ADD. 29.05.96	
07300183	CHAPEAU GROUPE PREMIER 2002 AGG. 30.08.2012	GROUP HEAD CAP	
07300212	BEC DEUX VOIES PETIT	TWO WAYS SPOUT	
07300218	RACCORD L 1/8 M-F 458	L FITTING 1/8" M-F	
07300221	VITE INOX ROBINET VAPEUR	STEAM VALVE INOX SCREW	
07300225	GICLEUR M8x8 F.3	GIGLEUR M8X8 F.3	
07300227	RONDELLE OT D.26x13,5x1,5 AGG.5.06.03	BRASS WASHER D.26X13,5X1,5	
07300293	JOINT RONDELLE. AG.25.06.96	BRASS BUSHING	
07300295	VIS POINTEAU RACC. 3/8 LANCE	WAND NUT 3/8	
07300354	CORPS ROB. VAPEUR x LANC. SNOD OTTONE OT-58	STEAM KNOB BODY X FLEXIBLE WAND	
07300355	FOURCHETTE ROBINET '99 OTTONE OT-58	TAP FORK	
07300362	RACCORD DER. 1/4 M-CALZ.6 340	STRAIGHT FITTING 1/4	
07300364	RACCORD DER. 1/8 M CON. - CALZAM.6 340	STRAIGHT FITTING 1/8 SHEATH TYPE D.6	
07300365	RACCORD T 1/4 M-F-F	T FITTING 1/4 FFM	
07300369	RACCORD ATTACHE POMPE ELECTROMECHANIQUE	FITTING DERECT DESCHARGE FOR PUMP	
07300382	RACCORD DER. 1/4 F - CALZAM.	CONNECTION DER. F 1/4 !! ACTUATOR	
07300450	RACCORD T 1/8 M-F-M	COUPLING T 1/8	
07300459	RACCORD CROIX 1/4 M-M-M-F	CROSS FITTING 1/4" M-M-M-F	
07300601	INCERE MANETTE PORTE FILTRE 2003 INOX (Aisi303)	FILTER HOLDER KNOB INSERTION 2003 STAINLESS	
07300684	GICLEUR M8x8 F.3,2	GIGLEUR M8X8 F.3,2	
07300714	RACCORD L 1/8 M - CALZAM.6	L FITTING 1/8 SHEAT TYPE D6	
07300720	RACCORD L 1/4 M - CALZAM.	L FITTING 1/4 M SHEAT TYPE	
07300810	PRISE ROB.VAPEUR AURELIA II	SPINOTTO RUB.VAPEUR AURELIA IIREPLACE 07300104	
07300860	GICLEUR ALIMENTATION 1/8 M-F F.0,7	WATER SUPPLY CALIBRATED ORIFICE 1/8" 0.7mm	
08000003	COLLIER SERRE TUYAU D9.1	HOSE CLAMP D9.1	
08000005	RESORT 6 ST 11,5X8,5X25 RUB.VAPEUR	STEAM VALVE SPRING	
08000015	ANNEAU SEEGER TYPE RS 5 INOX UN17434	SEEGER RING RS 5 STAINLESS STEEL	
08000017	RESORT BLOQUE FILTRE INOX	FILTER HOLDER SPRING INOX	
08000027	RESORT LANCE	WAND SPRING	
09000006	SONDE AUTO NIVEAU COMP. L=70 avec gorge	LEVEL PROBE REPLACE CODE 73003011	
09200006	PRESSOSTAT MACHINE CE/UL TRIF. 30A 400V	VARIABLE PRESSURE SWITCH 3P 30A 400V	
09200014	PRESSOSTAT "OSCAR" 1,4BAR 1/4	PRESSURE SWITCH 1P 16A 250V	
09500007	THERMO PROTECTEUR 2MMT 100C	2MMT 100°C THERMAL PROTECTION	
09500014	THERMO PROTECTEUR x RESISTANCE G5 167C 16A 250V UL	THERMO PROTECTOR	
11600002	TUYAU SILICONE 5x8 60Sh PEROX (1mt=37gr) TRASPARENT	SILICONE TUBE 5x8	
11740001	TUYAU TEFLON 6/4	TEFLON PIPE 4X6	
14100040	RESISTANCE CHAUDIERE OSCAR 1" 1200W 230V +T.P.	HEATING ELEMMENT OSCAR 1200W 230V 1"	
14100041	RESISTANCE CHAUDIERE OSCAR 1" 1200W 115V +T.P.	HEATING ELEMENT OSCAR	
31000255	ETIQUETTE ADHESIVE SYMBOLE "TERRE" CERCLE	CIRCLED EARTH SYMBOL DECAL	
31000700	ETIQUETTE ADHESIVE OSCAR II	OSCAR II COVER LABEL	
73004013	GROUPE DE DISTRIBUTION CHROME. OT-58 OSCAR/MUSICA	CHROME POURING GROUP/ OSCAR	
73004014	GROUPE DE DISTRIBUTION . COMPLET. OSCAR 115V	POURING GROUP ASSEMBLY OSCAR 115 V	
73004015	GROUPE DE DISTRIBUTION. COMPLET. OSCAR 230V	POURING GROUP ASSEMBLY OSCAR 230 V	
75006038.1	BEC VAPEUR M8,65x0,75 F. 1.2 ESAG.12	STEAM NOZZLE M8,65x0,75 1.2mm HOLES	
98005024	CORPS PORTE FILTRE INCLINE + MANETTE N.S.	TILTED FILTERHOLDER +HANDLE	
98008004	PISTON FERMETURE COMPLET	COMPLETE STEAM VALVE PISTON	
98013020	VALVE SECURITE A5 1/4 TARATA 1,8 BAR	SAFETY VALVE 1/4 1.8 BAR	
98030440	CHAUDIERE SOUDEE OSCAR II	OSCAR II BOILER	
98030442	TUYAU VAPEUR - CHAUDIERE OSCAR II	PIPE BOILER-STEAM VALVE OSCAR II	
98030444	TUYAU PRESSOSTAT-CHAUDIERE OSCAR II	PIPE BOILER-PRESSURE SWITCH OSCAR II	
98030446	TUYAU SUPERIEUR GROUPE DIST.- CHAUDIERE OSCAR II	TOP PIPE HEAT EXCHANGER-GROUP OSCAR II	
98030448	TUYAU INFERIEUR GROUPE DIST.- CHAUDIERE OSCAR II	BOTTOM PIPE HEAT EXCHANGER-GROUP OSCAR II	
98060030	LANCE VAPEUR D8 OSCAR II OT CHROME	STEAM WAND OSCAR II	
98120001	VALVE NEPLAX VITON 16,5 BAR 1/8 - SUPPORT CAOUTCHOUC	NEPLAX VITON 16,5 BAR VALVE 1/8 HOSE CLAMP	
98110001	VALVE DE RETENUE COMPL. 1/8 F-F	RETAIN VALVE 1/8 F-F	
98200000000020	ENSEMBLE RESERVOIR EAU AVEC FLOTTEUR	WATER CONTAINER ASSEMBLY WITH FLOAT SENSOR	
980300000002600000	ENSEMBLE CHAUDIERE OSCAR II	COMPLETE BOILER ASSEMBLY OSCAR II	

Code 31000711
Ed. 01 of 12/2015



Nuova Simonelli S.p.A.

Via M. d'Antegiano, 6
62020 Belforte del Chienti
Macerata, Italy
Ph. +39.0733.9501
Fax +39.0733-950242
www.nuovasimonelli.it
E-mail: n.simonelli@nuovasimonelli.it

Nuova Distribution Centre

LLC 6940Salashan PKWY BLDG A 98248
Ferdale, WA
Ph. +1.360.3662226
Fax +1.3603664015
videoconf. +1.360.3188595
www.nuovasimonelli.it
info@nuovasimonelli.com

Nuova Simonelli reserves the right of make all modifications deemed to be necessary.